



QUALITY WITHOUT COMPROMISE – SINCE 1972

CATALOGUE
2025 / 26

Two manufacturers – one product – fifty years know-how!



The company Prinz Verlag developed a machine for producing stock sheets in the 1970s. Originally marketed under the name "Diamond Sheets," these sheets are now known as "Prinz-System" stock sheets.

This machine was the result of many years of intensive development, allowing for height variations in the strips to match the height of the stamps. This way, each stamp is completely covered by a protective film.

Around the same time, the company Hagner in Sweden was also producing similar sheets, initially by hand. The strips were first applied manually and then cut open at the top to create a pocket for inserting stamps.

As demand increased, Hagner also developed a machine to replace the labor-intensive manual production of "Hagner stock sheets".

Prinz and Hagner stock sheets are available in both single- and double-sided versions and offer two significant advantages over traditional stamp albums: the stamps are completely covered by a softener- and acid-free polyester strip, and the sheets are designed for ring binders. This makes them easily replaceable or expandable at any time.

With the purchase of this 1975 machine, Prinz continues the tradition of "Hagner stock sheets".

Thanks to the technology of both machines and years of expertise, Prinz is able to produce stock sheets of exceptional quality for special requirements.

The "Hagner stock sheets" are produced in 9 versions, each single or double-sided. They are made from black, ph-neutral cardboard. The glued-on, clear polyester strips do not contain any harmful chemicals. The outer format of the sheets is 215 x 280 mm (W x H) and are perforated with 7 holes.

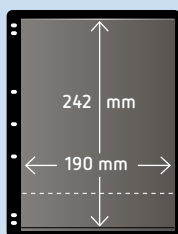

HS1/HSD1

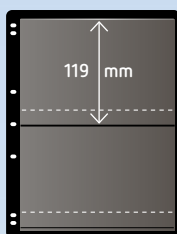

HS2/HSD2

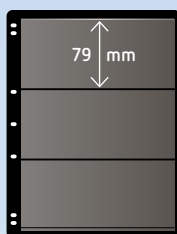

HS2/HSD3

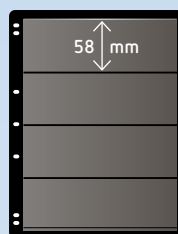

HS4/HSD4



HS5/HSD5

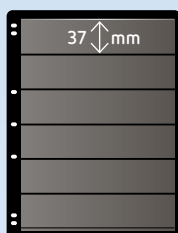

HS6/HSD6

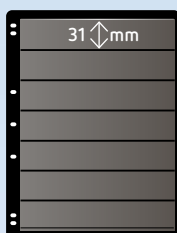

HS7/HSD7

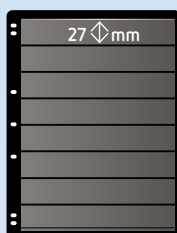

HS8/HSD8

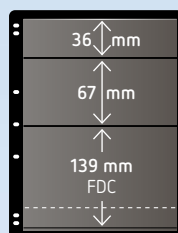

HS9/HSD9



QUALITY WITHOUT COMPROMISE

For five decades, the name Prinz has stood for high quality philatelic products. It all began in 1972 with the production of polystyrol stamp mounts and stockcards with polyester strips. In the following years, the range of accessories has continually expanded.

At the end of 1994, now in its second generation, the family run company, Prinz, built up a second business area in addition to manufacturing philatelic products, they started offering services to the philatelic trade. Album and catalogue manufacturers as well as postal administrations around the world are happy to take advantage of the range of complete solutions for the manufacture of their philately products.

The production of high-quality foil products is still the mainstay of the company. Polystyrol and polyester are free of harmful chemicals and thus enable postage stamps to be stored safely for decades. Another plus point of the Prinz products is the extra strong clamping force on foil mounts and stockcards, which securely holds the collector's items and prevents them from slipping or even falling out.

Throughout its history the company's philosophy remains unchanged: to continue offering an uncompromised commitment to high quality products and excellent customer satisfaction.

Content

Stamp mounts and sleeves	4
Stockcards	8
Stock sheets	14
Presentation systems	21
Blank systems	22
Ring binders	24
Stockbooks	30
Philately collector's accessories	36
Collector's accessories numismatics	42

STAMP MOUNTS



Mounts from polystyrol

Cut-to-size

Width x Height mm*	Quantity	Type**	Order-No. black	Order-No. transparent
20 x 24	25 pc.	S/G	S 2024	T 2024
20 x 26	25 pc.	S/G	S 2026	T 2026
21 x 24	25 pc.	S/G	S 2124	T 2124
21.5 x 26	25 pc.	S/G	S 21526	T 21526
21.5 x 30	25 pc.	S/G	S 21530	T 21530
23 x 27.5	25 pc.	S/G	S 23275	T 23275
24 x 20	25 pc.	S/G	S 2420	T 2420
24 x 21	25 pc.	S/G	S 2421	T 2421
24 x 28	25 pc.	S/G	S 2428	T 2428
24 x 40	25 pc.	S/G	S 2440	T 2440
24 x 41	25 pc.	S/G	S 2441	T 2441
25 x 30	25 pc.	S/G	S 2530	T 2530
26 x 21.5	25 pc.	S/G	S 26215	T 26215
26 x 31	25 pc.	S/G	S 2631	T 2631
26 x 36	25 pc.	S/G	S 2636	T 2636
26 x 40	25 pc.	S/G	S 2640	T 2640
26 x 41	25 pc.	S/G	S 2641	T 2641
26 x 43	25 pc.	S/G	S 2643	T 2643
27.5 x 33	25 pc.	S/G	S 27533	T 27533
29 x 36	25 pc.	S/G	S 2936	T 2936
30 x 25	25 pc.	S/G	S 3025	T 3025
30 x 39	25 pc.	S/G	S 3039	T 3039
31 x 24	25 pc.	S/G	S 3124	T 3124
31 x 26	25 pc.	S/G	S 3126	T 3126

Width x Height mm*	Quantity	Type**	Order-No. black	Order-No. transparent
33 x 27.5	25 pc.	S/G	S 33275	T 33275
36 x 26	25 pc.	S/G	S 3626	T 3626
36 x 29	25 pc.	S/G	S 3629	T 3629
39 x 30	25 pc.	S/G	S 3930	T 3930
40 x 24	25 pc.	S/G	S 4024	T 4024
40 x 26	25 pc.	S/G	S 4026	T 4026
41 x 24	25 pc.	S/G	S 4124	T 4124
41 x 26	25 pc.	S/G	S 4126	T 4126
43 x 26	25 pc.	S/G	S 4326	T 4326
28 x 47	25 pc.	S/G	S 2847	T 2847
29 x 49	25 pc.	S/G	S 2949	T 2949
30 x 41	25 pc.	S/G	S 3041	T 3041
33 x 55	25 pc.	S/G	S 3355	T 3355
35 x 35	25 pc.	S/G	S 3535	T 3535
40 x 33	25 pc.	S/G	S 4033	T 4033
40 x 49	25 pc.	S/G	S 4049	T 4049
41 x 30	25 pc.	S/G	S 4130	T 4130
41 x 41	25 pc.	S/G	S 4141	T 4141
41 x 53	25 pc.	S/G	S 4153	T 4153
46 x 27.5	25 pc.	S/G	S 46275	T 46275
49 x 40	25 pc.	S/G	S 4940	T 4940
53 x 41	25 pc.	S/G	S 5341	T 5341
55 x 33	25 pc.	S/G	S 5533	T 5533

*The specified size is stamp format, foil dimensions approx. 4 mm larger **Type Standard or Gard

Mounts from polystyrol

Polystyrol stamp mounts have been proven to be the safest material to store your valuable stamps and documents. The extra strong clamping effect of the mounts will securely hold your stamps in place preventing them from slipping out.

Stamp mounts are available in transparent (clear) or black backed and Standard (top opening) or Gard (back opening). Both formats are identical in quality.

Of course, the materials are free of plasticisers and harmful chemicals. Polystyrol is a proven archival quality material that will not damage your stamps.

- Clear transparency – crystal clear view of the stamps.
- A special gluing on the back makes additional adhesives unnecessary.
- A reinforced cover foil with unsurpassable clamping force guarantees stability and safety for many years.

Strips

Width x Height mm*	Quant.	Type**	Order-No. black	Order-No. transparent
210 x 16	25 pc.	S/G	S 200	T 200
210 x 20	25 pc.	S/G	S 240	T 240
210 x 21	25 pc.	S/G	S 250	T 250
210 x 24	25 pc.	S/G	S 280	T 280
210 x 26	25 pc.	S/G	S 300	T 300
210 x 27.5	25 pc.	S/G	S 315	T 315
210 x 28	25 pc.	S/G	S 320	T 320
210 x 29	25 pc.	S/G	S 330	T 330
210 x 30	25 pc.	S/G	S 340	T 340
210 x 31	25 pc.	S/G	S 350	T 350
210 x 32	25 pc.	S/G	S 360	T 360
210 x 33	25 pc.	S/G	S 370	T 370
210 x 35	25 pc.	S/G	S 390	T 390
210 x 36	25 pc.	S/G	S 400	T 400
210 x 39	25 pc.	S/G	S 430	T 430
210 x 40	25 pc.	S/G	S 440	T 440
210 x 41	25 pc.	S/G	S 450	T 450
210 x 43	25 pc.	S/G	S 470	T 470
210 x 44	25 pc.	S/G	S 480	T 480
210 x 48	25 pc.	S/G	S 520	T 520
210 x 49	25 pc.	S/G	S 530	T 530
210 x 52	25 pc.	S/G	S 560	T 560
210 x 53	25 pc.	S/G	S 570	T 570
210 x 55	25 pc.	S/G	S 590	T 590

Blockmounts

Width x Height mm*	Quant.	Type**	Order-No. black	Order-No. transparent
68 x 40	10 pc.	S/G	S 6840	T 6840
210 x 66	10 pc.	S/G	S 700	T 700
210 x 70	10 pc.	S/G	S 740	T 740
210 x 86	10 pc.	S/G	S 750	T 750
130 x 85	10 pc.	S/G	S 760	T 760
148 x 105	10 pc.	S/G	S 770	T 770
165 x 95	10 pc.	S/G	S 780	T 780
160 x 120	10 pc.	S/G	S 790	T 790
162 x 115	10 pc.	S/G	S 800	T 800
210 x 148	6 pc.	S/G	S 810	T 810
210 x 170	5 pc.	S/G	S 820	T 820
186 x 143	5 pc.	S/G	S 900	T 900
232 x 101	5 pc.	S/G	S 901	T 901
165 x 101	6 pc.	S/G	S 902	T 902
176 x 105	6 pc.	S/G	S 903	T 903
138 x 105	8 pc.	S/G	S 904	T 904
145 x 100	8 pc.	S/G	S 905	T 905
117 x 53	10 pc.	S/G	S 906	T 906
83 x 57	10 pc.	S/G	S 907	T 907
120 x 65	10 pc.	S/G	S 908	T 908
115 x 81	10 pc.	S/G	S 909	T 909
190 x 53	10 pc.	S/G	S 910	T 910
195 x 110	8 pc.	S/G	S 915	T 915
96 x 206	5 pc.	S/G	S 920	T 920
120 x 70	10 pc.	S/G	S 930	T 930
130 x 100	8 pc.	S/G	S 940	T 940
110 x 90	10 pc.	S/G	S 950	T 950

Assortments

Article	Scale	Type**	Order-No. black	Order-No. transparent
Kiloware	500 g	S/G	S 594	T 594
Kiloware	200 g	S/G	S 595	T 595
Kiloware	50 g	S/G	S 596	T 596
Strip assortment	18 pc.	S/G	S 597	T 597
Block assortment	9 pc.	S/G	S 825	T 825

*The specified size is stamp format, foil dimensions approx. 4 mm larger **Type Standard or Gard



Stamp mount
Standard

Open on three sides,
closed at the bottom



Stamp mount
Gard

Closed at the top and
bottom. The split back
allows the mount to
be lifted up and the
stamp to be conven-
iently inserted.

Sleeves from PP or hard PVC

These are the ideal protection for individual collector's items in different sizes and film qualities. Our sleeves are crystal clear, tear-proof, plasticiser and acid free. They are particularly suitable for storing picture postcards, letters of various sizes, stockcards, banknotes, and documents.

We differentiate between two different materials:

- Protective sleeves made of plasticiser-free hard film (PVC), which are particularly stable and crystal clear
- Protective sleeves made of the soft but nonetheless plasticiser-free polypropylene film (PP), slightly matt

Both materials offer secure protection for your documents.

Sleeves from PP or hard PVC

For postal stationery, postcards, stockcards, etc., crystal clear, tearproof, free of plasticisers. All pockets are open on the narrow side, except for those marked with an "L". These are open on the long side.

Sleeve format WxH mm	for inserts up to mm	Quantity	Order-No. PP	Order-No. PVC
101 x 145	95 x 143	100 pc.	5100*	5110*
113 x 152	106 x 150	100 pc.	5101*	5111*
118 x 157	112 x 155	100 pc.	5102*	—
104 x 170	98 x 167	100 pc.	5103*	—
124 x 170	118 x 167	100 pc.	5104*	5114*
124 x 223	118 x 220	100 pc.	5105*	—
130 x 238	124 x 235	100 pc.	5123*	—
134 x 190	128 x 187	100 pc.	5106*	5116*
154 x 213	148 x 210	100 pc.	5108*	5118*
156 x 87 „L“	148 x 84	100 pc.	5107*	—
164 x 115 „L“	156 x 112	100 pc.	5109*	—
217 x 154 „L“	212 x 150	100 pc.	5120**	—
218 x 161 „L“	212 x 158	100 pc.	5122**	—

* Film thickness = 100 µm / ** = 60 µm



Sleeves from OPP

These sleeves are made of stretched polypropylene and are highly transparent. OPP is physiologically harmless, free of plasticisers and contains neither chlorine nor heavy metals. OPP sleeves are water-repellent and impress with their low water vapor permeability. It is a resource-saving and environmentally friendly material, and 100% recyclable.

Other formats and quantities on request.

Sleeves from OPP

For postal stationery, postcards, stockcards, etc., crystal clear, tearproof, free of plasticisers. All pockets are open on the narrow side and have a flap with an adhesive closure, exception: 286 x 230mm – without flap, open on the long side.

Sleeve format WxH + flap mm	for inserts up to mm	Quantity	Order-No.
90 x 152 + 25	84 x 148	50 pc.	5221
115 x 152 + 25	112 x 148	50 pc.	5222
115 x 160 + 25	112 x 156	50 pc.	5223
118 x 165 + 25	114 x 162	50 pc.	5224
152 x 215 + 25	148 x 210	50 pc.	5225
286 x 230	282 x 224	50 pc.	5226

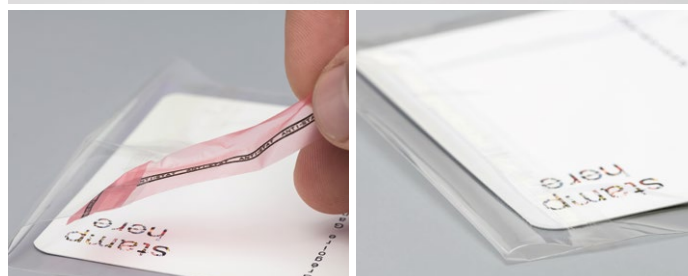

Glassine sleeves

Glassine is an environmentally friendly material and is made from cellulose. These bags are grease-proof, but not water-proof. The transparent paper (60g/m²) is acid-free, ensures long-term storage and is recyclable.

Glassine sleeves

For postage stamps, blocks, postal stationery etc., transparent, acid-free. All sleeves are open on the broad side and have a flap.

Sleeve format WxH + flap mm	Quantity	Order-No.
80 x 58 + 35	50 pc.	5231
114 x 81 + 35	50 pc.	5232
162 x 114 + 40	50 pc.	5233



STOCKCARDS



High quality

Environmentally friendly card

Excellent hold

Contaminant-free storage

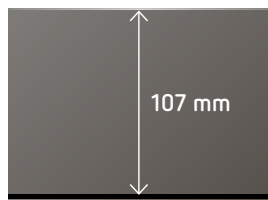

No. 0710, 148 x 112 mm, 1 strip
No. 0740, 156 x 112 mm, 1 strip

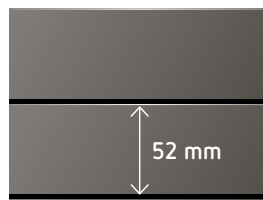

No. 0720, 148 x 112 mm, 2 strips
No. 0750, 156 x 112 mm, 2 strips

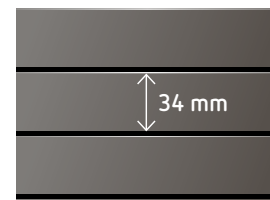

No. 0730, 148 x 112 mm, 3 strips
No. 0760, 156 x 112 mm, 3 strips

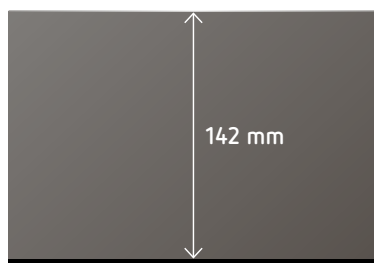

No. 0810, 210 x 148 mm, 1 strip

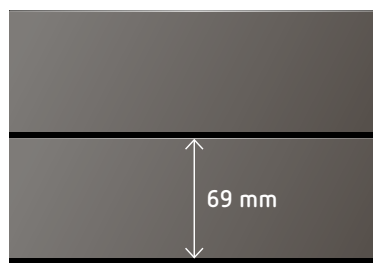

No. 0820, 210 x 148 mm, 2 strips

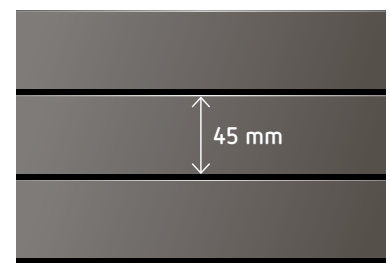

No. 0830, 210 x 148 mm, 3 strips

Premium stockcards black

Sturdy, black card, 270 gsm, pH-neutral, covered with polyester strips.

Format WxH mm	Strips	Quantity	Order-No.
148 x 112	1 strip	100 pc.	0710
148 x 112	2 strips	100 pc.	0720
148 x 112	3 strips	100 pc.	0730
156 x 112	1 strip	100 pc.	0740
156 x 112	2 strips	100 pc.	0750
156 x 112	3 strips	100 pc.	0760
210 x 148	1 strip	50 pc.	0810
210 x 148	2 strips	50 pc.	0820
210 x 148	3 strips	50 pc.	0830
210 x 148	4 strips	50 pc.	0840
210 x 148	5 strips	50 pc.	0850
148 x 210	1 strip	50 pc.	0991
148 x 210	2 strips	50 pc.	0992
148 x 210	3 strips	50 pc.	0993
148 x 210	4 strips	50 pc.	0994
148 x 210	5 strips	50 pc.	0995

(no illustration)

210 x 297	1 strip	10 pc.	0871
210 x 297	2 strips	10 pc.	0872
210 x 297	3 strips	10 pc.	0873
210 x 297	4 strips	10 pc.	0874
210 x 297	5 strips	10 pc.	0875
210 x 297	6 strips	10 pc.	0876
210 x 297	7 strips	10 pc.	0877
210 x 297	8 strips	10 pc.	0878

NEW

Premium stockcards

Our premium stockcards, whether black, coloured or white with black imprint, are manufactured in the well-known Prinz quality. This means that the card used for this is pH-neutral and the attached film strips are made of 100 µm polyester, absolutely free of plasticisers and acids.

A special feature of our premium stockcards is the maximum possible clamping force for a strong hold of the stamps and documents. In addition, your stamps are completely covered by foil and are therefore optimally protected. Due to the plasticiser-free polyester film, a safe storage time can be guaranteed for many years. Post administrations and auction houses in particular prefer this type of storage cards.

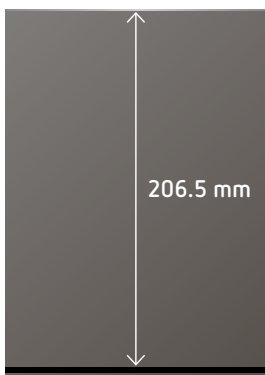

No. 0991, 148 x 210 mm, 1 strip

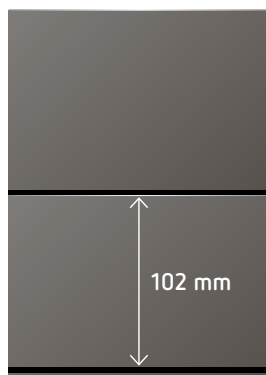

No. 0992, 148 x 210 mm, 2 strips

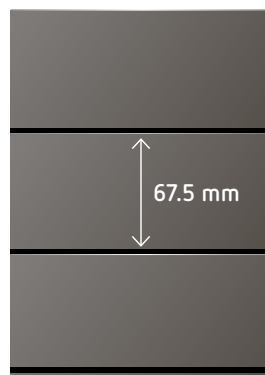

No. 0993, 148 x 210 mm, 3 strips



No. 0994, 148 x 210 mm, 4 strips

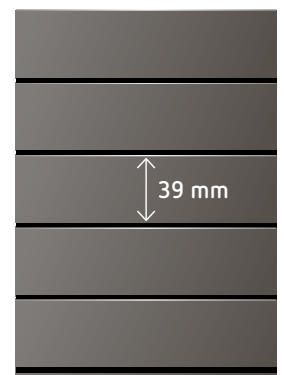

No. 0995, 148 x 210 mm, 5 strips

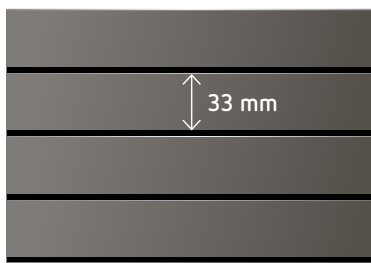

No. 0840, 210 x 148 mm, 4 strips

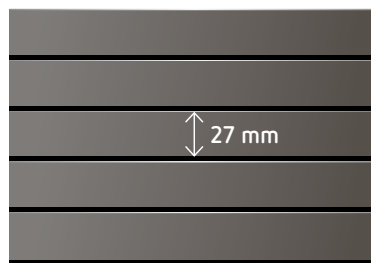

No. 0850, 210 x 148 mm, 5 strips

Accessories

You will find suitable storage boxes for your stockcards on page 41.





Premium stockcards

White stockcards made of 300 gsm card, printed, are ideal for labelling. This product is available in 3 different sizes, each with one or two polyester strips. The black background makes the stamps stand out very nicely. Yet there is still enough space for various notes, catalogue numbers or price quotations. Both collectors and dealers prefer our premium stockcards, especially on exchange days and trade fairs.

Premium stockcards white with print

Stable, white carrier card, 300 gsm, pH-neutral, with a black background in the stamp area and line for labelling, covered with polyester strips.

Format WxH mm	Strips	Quantity	Order-No.
148 x 84	1 strip	100 pc.	0910
148 x 84	2 strips	100 pc.	0920
156 x 112	1 strip	100 pc.	0930
156 x 112	2 strips	100 pc.	0940
210 x 148	1 strip	50 pc.	0950
210 x 148	2 strips	50 pc.	0960



No. 0910, 148 x 84 mm, 1 strip

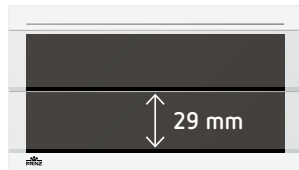

No. 0920, 148 x 84 mm, 2 strips



No. 0930, 156 x 112 mm, 1 strip

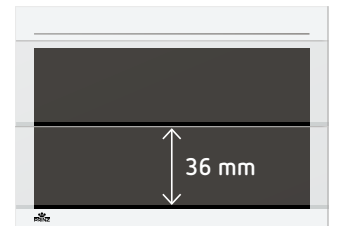

No. 0940, 156 x 112 mm, 2 strips

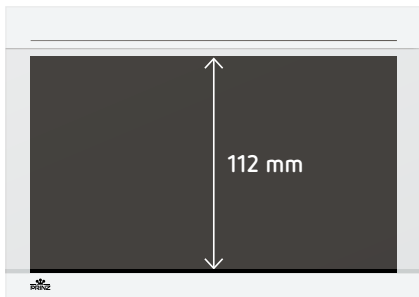

No. 0950, 210 x 148 mm, 1 strip



No. 0960, 210 x 148 mm, 2 strips

Accessories

You will find suitable storage boxes for your stockcards on page 41.

Premium stockcards in the colour and format of your choice

From an order quantity of 1,000 pieces, these cards can be produced in various formats and colours. Ask us – we will be happy to advise you.



Premium stockcards blue and red

Stable, solid-coloured carrier card, 250 gsm, pH-neutral, covered with polyester strips.

Format WxH mm	Colour	Strips	Quantity	Order-No.
156 x 112	blue	1 strip	100 pc.	0965
156 x 112	blue	2 strips	100 pc.	0970
156 x 112	red	1 strip	100 pc.	0975
156 x 112	red	2 strips	100 pc.	0980

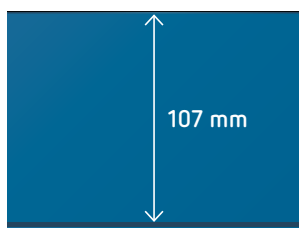

No. 0965, blue, 156 x 112 mm, 1 strip

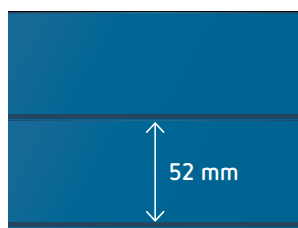

No. 0970, blue, 156 x 112 mm, 2 strips

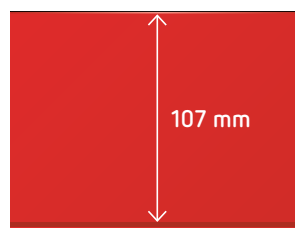

No. 0975, red, 156 x 112 mm, 1 strip



No. 0980, red, 156 x 112 mm, 2 strips



T 70721

Stockcards from polystyrol

The highly transparent design of these stockcards enables you to examine your stamps from both sides without removing them from the card. So, you can e.g. easily recognise hinge residues, gumming or repairs.

Stockcards from polystyrol

Transparent, format W x H 158 x 111 mm

Format WxH mm	Strips	Quantity	Order-No.
158 x 111	1 strip	100 pc.	T 70711
158 x 111	2 strips	100 pc.	T 70721
158 x 111	3 strips	100 pc.	T 70731
158 x 111	4 strips	100 pc.	T 70741



No. 70711, 158 x 111 mm, 1 strip

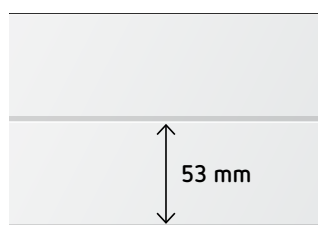

No. 70721, 158 x 111 mm, 2 strips

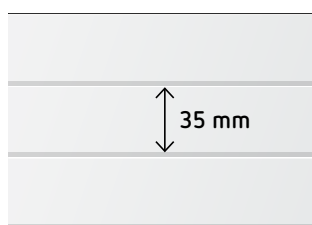

No. 70731, 158 x 111 mm, 3 strips



No. 70741, 158 x 111 mm, 4 strips

Stockcards from PVC

These stockcards are made with transparent welded strips on one side in 6 different strip heights. The border prevents the stamps from falling out.

The stockcards are characterised by their particular robustness and are therefore very durable. With the 6 different variants, you have all the options to perfectly organise your stamps. We also offer suitable crystal-clear protective clamping sleeves, also made of hard PVC, as additional protection.



No. 5093 with protective clamping sleeve 0581

Stockcards from PVC

Black carrier film made of PVC, format W x H 210 x 145 mm, free of plasticisers, with welded clear strips of PVC.

Format WxH mm	Strips	Quantity	Order-No.
210 x 145	1 strip	50 pc.	5091
210 x 145	2 strips	50 pc.	5092
210 x 145	3 strips	50 pc.	5093
210 x 145	4 strips	50 pc.	5094
210 x 145	5 strips	50 pc.	5095
210 x 145	6 strips	50 pc.	5096
205 x 147	Protective clamping sleeve	100 pc.	0580
205 x 147	Protective clamping sleeve	10 pc.	0581

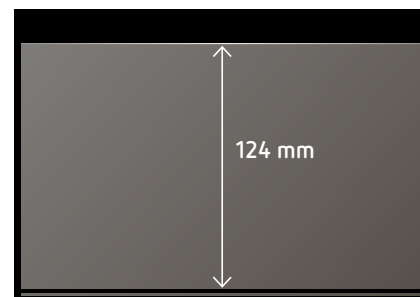

No. 5091, 210 x 145 mm, 1 strip

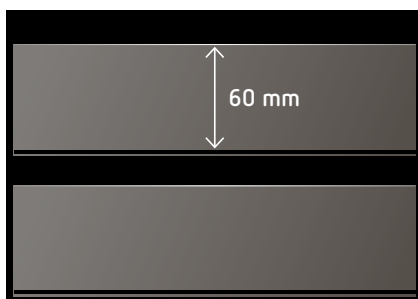

No. 5092, 210 x 145 mm, 2 strips



No. 5093, 210 x 145 mm, 3 strips



No. 5094, 210 x 145 mm, 4 strips

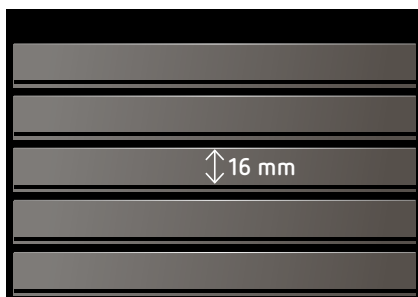

No. 5095, 210 x 145 mm, 5 strips

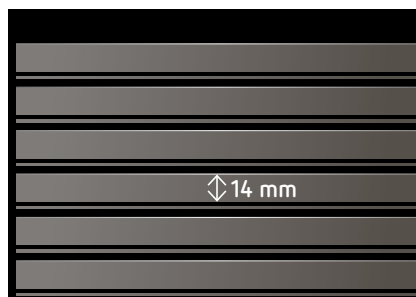

No. 5096, 210 x 145 mm, 6 strips

Accessories



You will find suitable storage boxes for your stockcards on page 41.

Stockcards for auctions

Black card with a grey back, 300 gsm, covered with crystal-clear strips of PVC. Available with and without cover foil.

Format WxH mm	Type	Quantity	Order-No.
148 x 84	2 strips, without cover foil	100 pc.	0400
148 x 84	2 strips, with cover foil	100 pc.	0450
156 x 112	3 strips, without cover foil	100 pc.	0500
156 x 112	3 strips, with cover foil	100 pc.	0550
210 x 148	5 strips, without cover foil	100 pc.	0600
210 x 148	5 strips, with cover foil	100 pc.	0650

Stockcards for auctions

These stockcards have card backing with clear PVC strips. They are available in various sizes with or without a cover foil, they offer excellent value and are the preferred choice for auction houses. However, they are also ideal for short-term storage or for exchange days.

practical & cheap

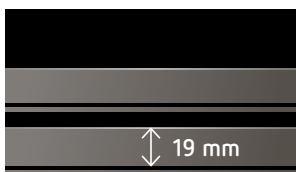

No. 0400, 148 x 84 mm, 2 strips, without cover foil

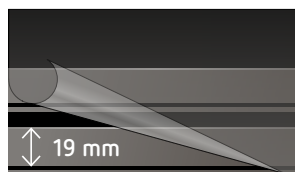

No. 0450, 148 x 84 mm, 2 strips, with cover foil



No. 0500, 156 x 112 mm, 3 strips, without cover foil

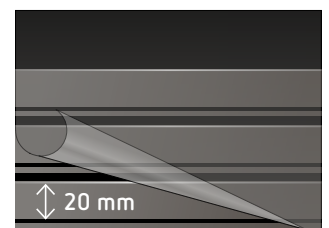

No. 0550, 156 x 112 mm, 3 strips, with cover foil

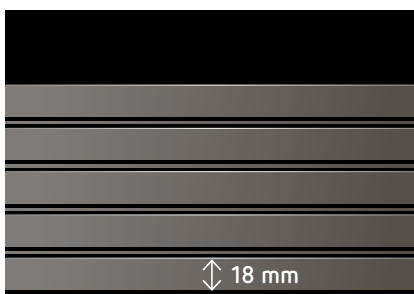

No. 0600, 210 x 148 mm, 5 strips, without cover foil

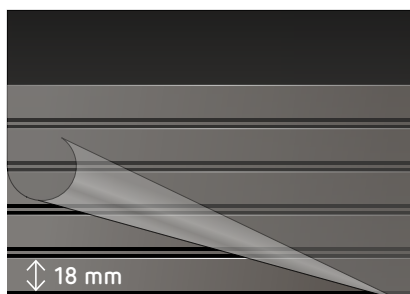

No. 0650, 210 x 148 mm, 5 strips, with cover foil

Accessories

You will find suitable storage boxes for your stockcards on page 41.



STOCK SHEETS

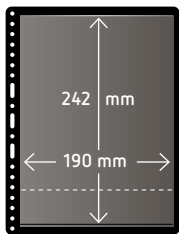

6061

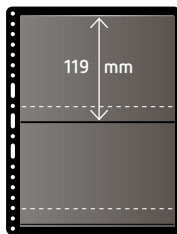

6062

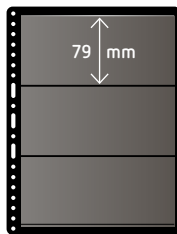

6063

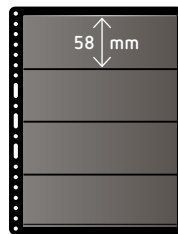

6064

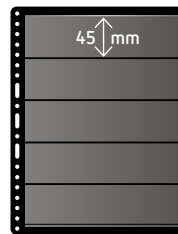

6065



6066

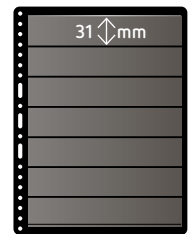

6067

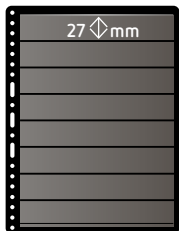

6068

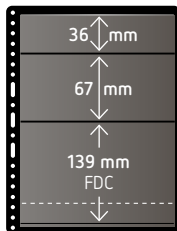

6069

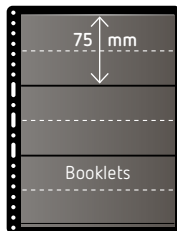

6083

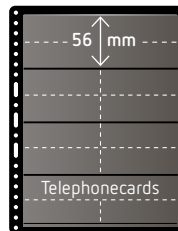

6084

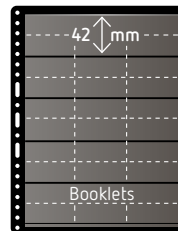

6085

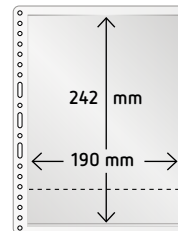

7281

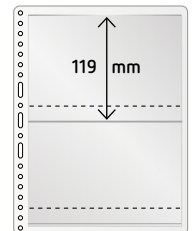

7282

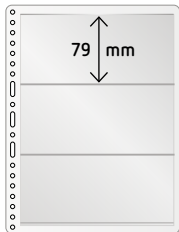

7283

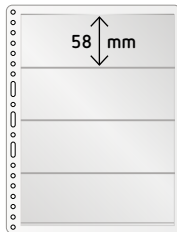

7284



7285



7286



7287

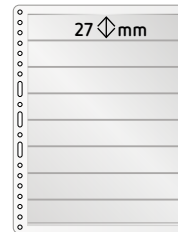

7288

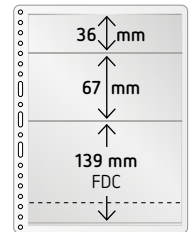

7289

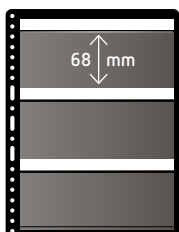

6093

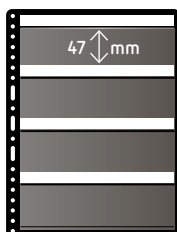

6094

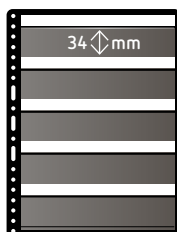

6095

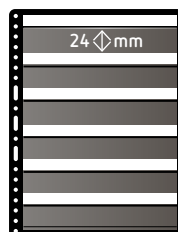

6096

Accessories

You can find suitable ring binders (Montana, Colorado, Arizona, Nevada) for your stock sheets on pages 24-26.



Prinz-System stock sheets

Prinz-System is synonymous with stock sheets and is the result of long and intensive product development. Prinz-System stock sheets in the format 215 x 280 mm are made from pH-neutral card and covered with plasticiser-free and acid-free polyester strips (100 µm). These do not contain any harmful chemicals. The extra-strong clamping force of the polyester strips ensures that stamps or other documents do not slip. In addition, the stamps are completely covered by the foil, so that a cover for further protection is not necessary. Storage for decades has been proven to be safe.

The **Prinz-Plus-System** also offers the option of writing-up stock sheets. The supplied perforated writing sheets can be written on by hand or by printer. The label is then inserted into the special strip on the sheet.



7286



6094 Plus-System

can be individually labelled

Prinz-System stock sheets black or white

Black or white album card, 270 gsm, pH-neutral, covered with clear polyester strips. Format W x H 215 x 280 mm, with universal or 7-hole punching, available single- and double-sided.

Type	Strip height mm	Strip width mm	Order-No. Universal punching Black sheet	Order-No. 7-hole punching Black sheet	Order-No. Universal punching White sheet			
						5 pc.	10 pc.	100 pc.*
1 strip, single-sided	242	190	6061	6761	7281	–	☑	☑
1 strip, double-sided	242	190	6071	6771	7291	–	☑	☑
2 strips, single-sided	119	190	6062	6762	7282	–	☑	☑
2 strips, double-sided	119	190	6072	6772	7292	–	☑	☑
3 strips, single-sided	79	190	6063	6763	7283	–	☑	☑
3 strips, double-sided	79	190	6073	6773	7293	–	☑	☑
4 strips, single-sided	58	190	6064	6764	7284	–	☑	☑
4 strips, double-sided	58	190	6074	6774	7294	–	☑	☑
5 strips, single-sided	45	190	6065	6765	7285	–	☑	☑
5 strips, double-sided	45	190	6075	6775	7295	–	☑	☑
6 strips, single-sided	37	190	6066	6766	7286	–	☑	☑
6 strips, double-sided	37	190	6076	6776	7296	–	☑	☑
7 strips, single-sided	31	190	6067	6767	7287	–	☑	☑
7 strips, double-sided	31	190	6077	6777	7297	–	☑	☑
8 strips, single-sided	27	190	6068	6768	7288	–	☑	☑
8 strips, double-sided	27	190	6078	6778	7298	–	☑	☑
3 strips, single-sided	36/67/139	190	6069	6769	7289	–	☑	☑
3 strips, double-sided	36/67/139	190	6079	6779	7299	–	☑	☑
3 strips, single-sided (Stamp booklets)	75	190	6083	6783	–	☑	–	–
4 strips, single-sided (Phone cards)	56	190	6084	6784	–	☑	–	–
5 strips, single-sided (Stamp booklets)	42	190	6085	6785	–	☑	–	–
3 strips, single-sided (Plus-System)	68	190	6093	6793	–	☑	–	–
4 strips, single-sided (Plus-System)	47	190	6094	6794	–	☑	–	–
5 strips, single-sided (Plus-System)	34	190	6095	6795	–	☑	–	–
6 strips, single-sided (Plus-System)	24	190	6096	6796	–	☑	–	–
Blank sheets	–	–	6099	6799	7280	–	☑	–

* When ordering a pack of 100 stock sheets, please add "/ 100" to order-no., e.g. 6061/100

Texas stock sheets

Texas stock sheets are slightly larger than Prinz-System sheets (format: 267 x 295 mm) and thus offer a little more space for your collection.

They are the result of long and intensive development work. Texas stock sheets are made from pH-neutral card and covered with plasticiser-free and acid-free polyester strips (100 µm). These do not contain any harmful chemicals.

The extra-strong clamping force of the polyester strips ensures that stamps or other documents do not slip. In addition, the stamps are completely covered by the foil, so that a cover for further protection is not necessary. Storage for decades has been proven to be safe.

The 8 versions offered are available with both black and white card.



TEXAS STOCK SHEETS black or white

Black or white album card, 270 gsm, pH-neutral, covered with clear polyester strips.
Format W x H 267 x 295 mm, with universal punching, available single- and double-sided.

Type	Strip height mm	Strip width mm black/white	Quantity	Order-No. Universal punching Black sheet	Order-No. Universal punching White sheet
1 strip, single-sided	242	240/210	5 pc.	0031	0021
1 strips, double-sided	242	240/-	5 pc.	0041	-
2 strips, single-sided	120	240/210	5 pc.	0032	0022
2 strips, double-sided	120	240/-	5 pc.	0042	-
3 strips, single-sided	79	240/210	5 pc.	0033	0023
3 strips, double-sided	79	240/-	5 pc.	0043	-
4 strips, single-sided	58	240/210	5 pc.	0034	0024
4 strips, double-sided	58	240/-	5 pc.	0044	-
5 strips, single-sided	46	240/210	5 pc.	0035	0025
5 strips, double-sided	46	240/-	5 pc.	0045	-
6 strips, single-sided	37	240/210	5 pc.	0036	0026
6 strips, double-sided	37	240/-	5 pc.	0046	-
7 strips, single-sided	31	240/210	5 pc.	0037	0027
7 strips, double-sided	31	240/-	5 pc.	0047	-
8 strips, single-sided	27	240/210	5 pc.	0038	0028
8 strips, double-sided	27	240/-	5 pc.	0048	-
Blank sheets, white, with frame	-	-	10 pc.	-	0020
Blank sheets, black, unprinted	-	-	10 pc.	0040	-

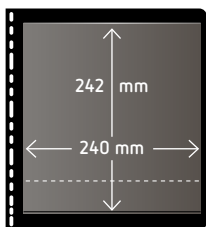

0031

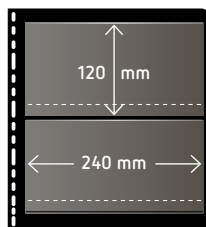

0032

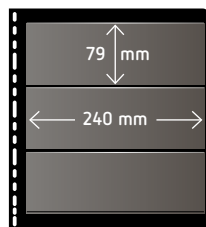

0033

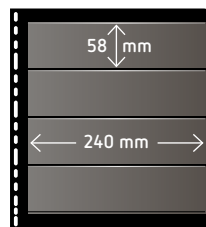

0034

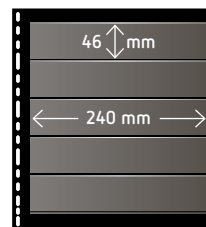

0035

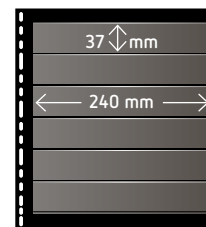

0036

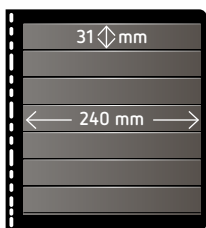

0037

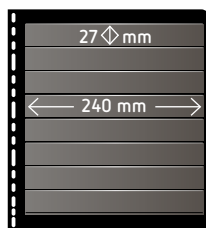

0038

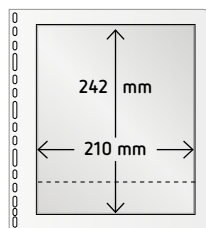

0021

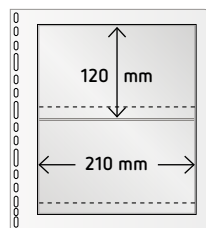

0022

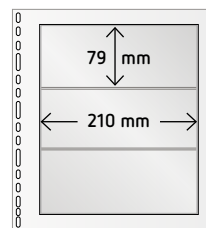

0023

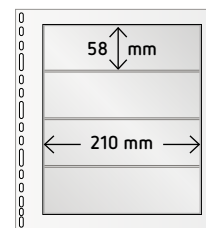

0024

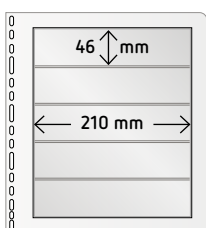

0025

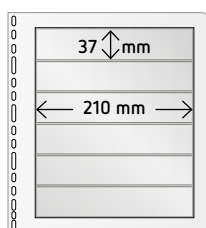

0026

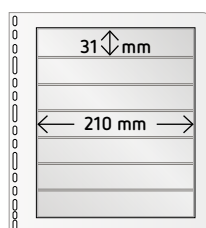

0027

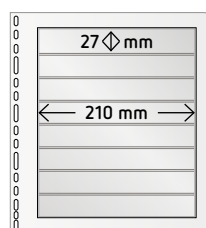

0028

Accessories

You can find suitable ring binders (Kansas, Texas) for your stock sheets on pages 26-27.



ProFil stock sheets from PVC

Of course, our PVC products are also made of high-quality materials and thus offer good protection for all philatelic items. Like all of Prinz's own products, these are also manufactured in Germany.

ProFil system stock sheets are available both in black and in a transparent version in the format 215 x 280 mm. The ten or twelve different variants offer space for all imaginable collectibles.



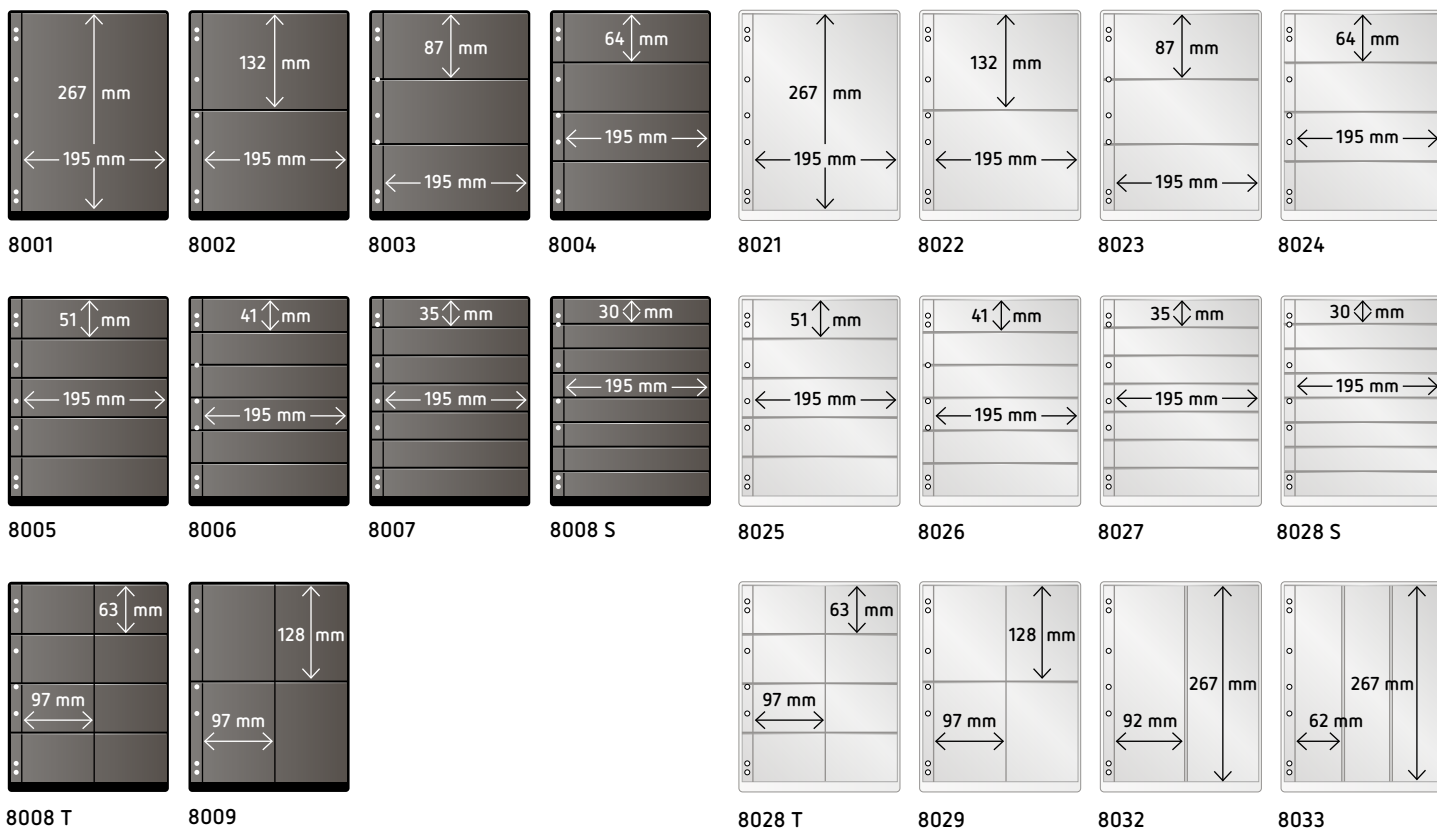

ProFil stock sheets from PVC, black or transparent

Stock pages made of PVC, plasticiser-free, format W x H 215 x 280 mm, 7-hole punching.
Black stock pages double-sided, transparent stock pages single-sided.

Type	Strip height mm	Strip width mm	Order-No. 7-hole punching Black sheet	Order-No. 7-hole punching Transparent sheet	5 pc.	100 pc.*
1 strip	267	195	8001	8021	☑	☑
2 strips	132	195	8002	8022	☑	☑
3 strips	87	195	8003	8023	☑	☑
4 strips	64	195	8004	8024	☑	☑
5 strips	51	195	8005	8025	☑	☑
6 strips	41	195	8006	8026	☑	☑
7 strips	35	195	8007	8027	☑	☑
8 strips	30	195	8008 S	8028 S	☑	☑
8 division	63	2x97	8008 T	8028 T	☑	☑
4 division	128	2x97	8009	8029	☑	☑
2 division vertical	267	2x92	–	8032	☑	☑
3 division vertical	267	3x62	–	8033	☑	☑
Blank sheets, black, made of PVC	–	–	8034	–	☑	–
Blank sheets, black, made of card	–	–	8035	–	☑	–

* When ordering a pack of 100 stock sheets, please add "/ 100"
to order-no., e.g. 8001/100

Accessories

You can find suitable ring binders (Montana, Colorado, Arizona, Nevada) for your stock sheets on pages 24–26.



Postcard stock sheets

They are the ideal addition to collecting classic and modern postcards. The pH-neutral card sheets in the format 180 x 250 mm are each equipped with 2 pockets made of polyester film on the front and back.

Postcard stock sheets

Black album card, 270 gsm, pH-neutral, covered with clear polyester strips, Format W x H 180 x 250 mm, strip width 160 mm, 4-hole punching (45-65-45).

Format WxH mm	Type	Quantity	Order-No.
180 x 250	2 strips, double-sided	10 pc.	5037
180 x 250	Blank sheets	5 pc.	5038

Accessories

You can find suitable ring binders (Alaska) for your stock sheets on page 28.



5037

PVC stock sheets for letters, FDC and banknotes

For the storage of larger documents, such as letters, etc., a wide variety of stock sheets are available in 2 different formats. Thanks to the high-quality processed transparent hard PVC film sheets in 1–3-part design, you can clearly store your collectibles. A safe hold and protection is always guaranteed. Thanks to the black card insert, all sheets can be filled double-sided. If you remove the card insert, you can see your items from both sides.

PVC stock sheets

Crystal clear PVC sheets, plasticiser-free, with black insert sheet (removable), 4-hole punching (80-80-80).

Format WxH mm	Type	Quantity	Order-No.
265 x 297	e.g. for ring binder Texas / Kansas, one-piece, content up to 235 x 285 mm	10 pc.	5077
265 x 297	e.g. for ring binder Texas / Kansas, two-part, content up to 235 x 140 mm	10 pc.	5078
265 x 297	e.g. for ring binder Texas / Kansas, three-part, content up to 235 x 91 mm	10 pc.	5079
210 x 250	e.g. for ring binder Alaska, one-piece, content up to 180 x 240 mm	10 pc.	5025
210 x 250	e.g. for ring binder Alaska, two-part, content up to 180 x 115 mm	10 pc.	5026



5025

5079

Accessories

You can find suitable ring binders (Kansas, Texas, Alaska) for your stock sheets on pages 26-28.



Exposafe Display

The high-quality and practical presentation system is available in 3 different versions – as a carousel, standing and wall model. All 3 stands are made of metal, have good stability and are equipped with pockets made of extra strong, crystal-clear hard PVC sleeves with a metal frame all around. All stands are supplied with a variation of different Prinz-System stock sheets (single-sided). The pockets can be easily exchanged and can be secured against theft with a security lock.

The Exposafe stands are indispensable helpers for trade fairs or exchange days.

Exposafe Display

Presentation system for browsing through, with pockets to hold Prinz-System stock sheets, format W x H 215 x 280 mm (optional), with security lock.

Type	Quantity	Order-No.
Exposafe table stand with 30 pockets	1 pc.	7011
Exposafe table stand with 30 pockets and 60 Prinz-System sheets	1 pc.	7012
Exposafe carousel stand with 50 pockets	1 pc.	7013
Exposafe carousel stand with 50 pockets and 100 Prinz system sheets	1 pc.	7014
Exposafe double carousel stand with 100 pockets and 200 Prinz-System sheets (not shown)	1 pc.	7014D
Exposafe wall stand with 10 pockets	1 pc.	7015
Exposafe wall stand with 10 pockets and 20 Prinz-System sheets	1 pc.	7016
Exposafe pocket	1 pc.	7017
Exposafe pocket with 2 Prinz-System sheets	1 pc.	7018



7016 Exposafe wall stand with 10 pockets and 20 sheets



7012 Exposafe table stand with 30 pockets and 60 sheets



7014 Exposafe carousel stand with 50 pockets and 100 sheets

Accessories

Matching Prinz-System stock sheets can be found on page 14.



BLANK SYSTEM



Blank system Classic

The blank system Classic is something for individualists and offers the option of adding special items to your pre-printed album. You can easily expand your collection according to your own wishes (e.g. blocks, varieties, misprints or joint issues ...). Of course, you can also put together a complete album individually.

The blank sheets 0001 – 0003 in the format 267 x 295 mm are available in 3 versions: Unprinted, only with a frame or with a 5 mm grid field printed in a light shade, which makes it easier for you to divide the sheets.

The matching sheet protectors, item no. 0008 complete the system. The blank sheets 0004 and 0005 are available in a slightly smaller format of 215 x 280 mm.

With Prinz stamp mounts (p. 4/5) and the indispensable cutting devices (p. 36) you can turn it into an album according to your style.

Blank system Classic

Stable, white album card, 300 gsm, suitable for many pre-printed albums. Suitable protective sleeves made of PVC, free of plasticisers.

Format WxH mm	Type	Quantity	Order-No.
267 x 295	Universal punching, unprinted	25 pc.	0001
267 x 295	Universal punching, with frame	25 pc.	0002
267 x 295	Universal punching, with frame and grid field (208 x 252 mm)	25 pc.	0003
215 x 280	4-hole punching, unprinted	25 pc.	0005
215 x 280	4-hole punching, with frame and grid field (180 x 248 mm)	25 pc.	0004
272 x 305	Sheet protector with universal punching for sheet format 267 x 295 mm	5 pc.	0008
240 x 310	Sheet protector with 4-hole punching for sheet format 215 x 300 mm (not shown)	5 pc.	0009

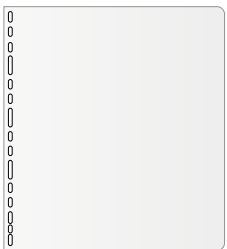

0001

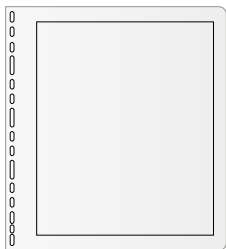

0002

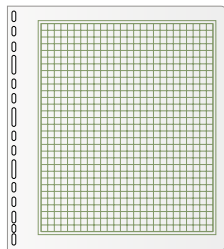

0003

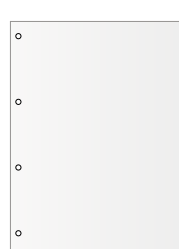

0005

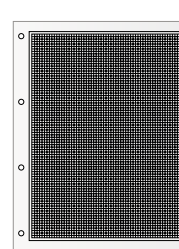

0004



0008

Accessories

You can find suitable ring binders for your album sheets on pages 24–28.



Accessories

You will find suitable stamp mounts for your album sheets on pages 4–5.



Accessories

Matching cutting devices for stamp mounts on page 36.



Blank system compage

This system allows you to design your album sheets yourself. With a standard A4 printer, you can print out your creations and, with the help of the accompanying compage punched strip, transform them into a perfect album sheet – suitable for every standard binder.

Highest quality in A4 format, available in the paper tints white and chamois, colour-coordinated with the corresponding punched strip.

We recommend the Prinz Strip-mounter for easy and precise attachment of the compage punched strip.

Now it's up to you to let your creativity and imagination run free. Design your album pages with scans of postage stamp images and text of your choice.



Blank system compage

Set consists of 20 card sheets, 170 gsm, format W x H 210 x 297 mm and 20 punched strips.

Sheet format WxH mm	Type	Quantity	Order-No.
210 x 297	Universal punching, white	1 Set	0050
210 x 297	Universal punching, cream	1 Set	0060
210 x 297	13-hole punching, white	1 Set	0050/13
210 x 297	13-hole punching, cream	1 Set	0060/13
210 x 297	14-hole punching, white	1 Set	0050/14
210 x 297	14-hole punching, cream	1 Set	0060/14
210 x 297	15-hole punching, white	1 Set	0050/15
210 x 297	15-hole punching, cream	1 Set	0060/15
210 x 297	18-hole punching, white	1 Set	0050/18
210 x 297	18-hole punching, cream	1 Set	0060/18
210 x 285	22-hole punching, white	1 Set	0050/22
210 x 285	22-hole punching, cream	1 Set	0060/22

Compage punched strips separately (no set)

40 pieces – for version please add ending (L) to the corresponding order-no. append, e.g. 0050/13 (L)

Mounting aid for punched strips

Prinz Strip-mounter	1 pc.	0100
---------------------	-------	------

Printed out on compage album card, all you have to do is attach the compage punched strip and equip the album sheet with Prinz stamp mounts. Ideally, cut the Prinz stamp mounts to the correct pocket size with the help of a Prinz cutter (p. 36).

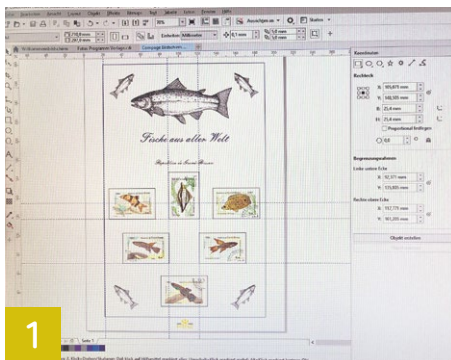

Accessories

You can find suitable ring binders for your album sheets on pages 24–28.



Accessories

You will find suitable stamp mounts for your album sheets on pages 4–5.



Accessories

Matching cutting devices for stamp mounts on page 36.



RING BINDERS

NEW



Ring binder Montana

For the first time, we are offering ring binders with high-quality and sustainable linen cover as a new addition to our range. Choosing this material helps us to reduce the impact on the environment. The ring binder is delivered together with a matching, linen-covered cassette. A standard 4-D ring mechanism can hold up to 50 Prinz-System stock sheets. The ring binders are available in 4 colours.

Ring binder Montana

Format W x H 250 x 315 mm, standard 4-D ring mechanism (80-80-80), including protective slipcase with linen cover, for max. 50 sheets, format max. W x H 215 x 280 mm.

Type	Quantity	Order-No.
Ring binder Montana, dark grey	1 pc.	7035.1
Ring binder Montana, red	1 pc.	7035.2
Ring binder Montana, blue	1 pc.	7035.3
Ring binder Montana, green	1 pc.	7035.4

Ring binder Arizona

The high-quality ring binders of the Arizona series are made of hard-wearing, lightly structured PVC film and are available in 3 colours. An additional quality feature is the padded design of the cover.

A standard 4-D ring mechanism ensures a secure hold for up to 80 sheets, e.g. our Prinz-System or ProFil stock sheets. With the larger capacity and the high-quality design, this binder offers an extremely convincing price-performance ratio.

Ring binder Arizona

Format W x H 265 x 310 mm, standard 4-D ring mechanism (80-80-80), for max. 80 sheets, format max. W x H 215 x 280 mm.

Type	Quantity	Order-No.
Ring binder Arizona, wine red	1 pc.	7025.2
Ring binder Arizona, blue	1 pc.	7025.3
Ring binder Arizona, green	1 pc.	7025.4



Ring binder Nevada

The ring binders of the Nevada series are made of high-quality, grained PVC film and thus give the binders a classic, leather-like character. An additional quality feature is the padded design of the cover.

These binders are suitable for storing of Prinz-System stock sheets and ProFil (page 15/19).

The 4-ring mechanism ensures a secure hold for up to 30 stock sheets. A pocket on the spine also offers the option of labelling the binders. The ring binders are available in 5 colours.

Ring binder Nevada

Format W x H 260 x 305 mm, 4-ring mechanism (80-80-80), for max. 30 sheets, format max. W x H 215 x 280 mm, protective slipcase made of covered card in 5 colours.

Type	Quantity	Order-No.
Ring binder Nevada, black (1)	1 pc.	5040.1
Ring binder Nevada, red (2)	1 pc.	5040.2
Ring binder Nevada, blue (3)	1 pc.	5040.3
Ring binder Nevada, green (4)	1 pc.	5040.4
Ring binder Nevada, brown (5)	1 pc.	5040.5
Protective slipcase, colour selection No. 1/2/3/4/5	1 pc.	5041.No

RING BINDERS

Ring binder Colorado

Formerly known as the "Diamant" binder, this product is one of the most popular among collectors.

The padded binders made of foamed PVC film are equipped with a standard 4-ring mechanism. The smooth, shiny surface gives this article a noble character. The binders of the Colorado series are particularly suitable for storing our popular Prinz-System or ProFil stock sheets. These binders are available in 5 colours.

Ring binder Colorado

Format W x H 250 x 310 mm, standard 4-ring mechanism (80-80-80), including protective slipcase, for max. 50 sheets, format max. W x H 215 x 280 mm.

Type	Quantity	Order-No.
Ring binder Colorado, black	1 pc.	7029.1
Ring binder Colorado, wine red	1 pc.	7029.2
Ring binder Colorado, blue	1 pc.	7029.3
Ring binder Colorado, green	1 pc.	7029.4
Ring binder Colorado, brown	1 pc.	7029.5



Ring binder Kansas

The high-quality ring binders of the Kansas series are made of hard-wearing, grained PVC film and are available in 4 colours. An additional quality feature is the padded design of the cover. These ring binders are deliberately kept simple and are particularly suitable for storing Prinz blank sheets or the popular Prinz compage sheets. A standard 4-ring mechanism ensures a secure hold for up to 40 sheets.

Ring binder Kansas

Format W x H 300 x 315 mm, standard 4-ring mechanism (80-80-80), for max. 40 sheets, format max. W x H 270 x 300 mm, protective slipcase made of covered card in 4 colours.

Type	Quantity	Order-No.
Ring binder Kansas, black (1)	1 pc.	5080.1
Ring binder Kansas, red (2)	1 pc.	5080.2
Ring binder Kansas, blue (3)	1 pc.	5080.3
Ring binder Kansas, green (4)	1 pc.	5080.4
Protective slipcase, colour selection No. 1/2/3/4	1 pc.	5076.No

Ring binder Texas

For the first time, we are offering ring binders with high-quality and sustainable linen cover as a new addition to our range. Choosing this material helps us to reduce the impact on the environment. The ring binders are offered together with matching, linen-covered slipcases and are available in 4 colours. A standard 4-D ring mechanism can hold up to 80 Texas sheets or Prinz blank sheets and Prinz compage sheets. The elegant embossing on the back gives these binders a particularly elegant touch.

Ring binder Texas

Format W x H 320 x 315 mm, standard 4-D ring mechanism (80-80-80), for max. 80 sheets, format max. W x H 267 x 295 mm, protective slipcase with linen cover in 4 colours.

Type	Quantity	Order-No.
Ring binder Texas, dark grey (1)	1 pc.	3080.1
Ring binder Texas, red (2)	1 pc.	3080.2
Ring binder Texas, blue (3)	1 pc.	3080.3
Ring binder Texas, green (4)	1 pc.	3080.4
Protective slipcase, colour selection No. 1/2/3/4	1 pc.	3081.No



RING BINDERS

Ring binder Alaska

The ring binders of the Alaska series are made of high-quality, grained PVC film and thus give the binders a classic, leather-like character. An additional quality feature is the padded design of the cover.

These binders are suitable for storing stock sheets item no. 5025, 5026, e.g. for letters and item no. 5037, for postcards.

The 4-ring mechanism ensures a secure hold for up to 30 stock sheets. A pocket on the spine also offers the option of labelling the binders. The ring binders are available in 5 colours.



Ring binder Alaska

Format W x H 250 x 270 mm, 4-ring mechanism (45-65-45), for max. 30 sheets, format max. W x H 210 x 250 mm, protective slipcase made of covered card in 5 colours.

Type	Quantity	Order-No.
Ring binder Alaska, black (1)	1 pc.	5036.1
Ring binder Alaska, red (2)	1 pc.	5036.2
Ring binder Alaska, blue (3)	1 pc.	5036.3
Ring binder Alaska, green (4)	1 pc.	5036.4
Ring binder Alaska, brown (5)	1 pc.	5036.5
Protective slipcase, colour selection No. 1/2/3/4/5	1 pc.	5034.No

FDC binder long

Our FDC binder long is equipped with a 2-ring mechanism. It contains 20 clear foil pockets with a black interleaf for 40 letters. The smooth synthetic leather cover made of PVC with fine gold embossing is available in 2 colours.

FDC binder long – Set

Format W x H 300 x 155 mm, 2-ring mechanism, including 20 FDC clear foil pockets made of clear PP film, with black insert sheet (removable), suitable for 40 letters up to format max. 225 x 130 mm.

Type	Quantity	Order-No.
FDC binder long, 20 foil pockets, red	1 pc.	2077.2
FDC binder long, 20 foil pockets, blue	1 pc.	2077.3
FDC foil pocket up to format max. 225 x 130 mm	10 pc.	2076

incl.
20 foil
pockets



FDC binder standard

This binder is ideal for the safe storage of FDCs in sizes up to 190 x 125 mm. The padded cover is made of high-quality, leather-like plastic (PVC), which is easy to open thanks to the snap fastener. A pocket on the spine offers the possibility to label the binder.

FDC binder standard – Set

Format W x H 240 x 145 mm, 2-ring snap fastener, including 50 FDC foil pockets made of clear PP film, with black insert sheet (removable), suitable for 100 letters up to format max. 190 x 125 mm.

Type	Quantity	Order-No.
FDC binder standard, black (1)	1 pc.	5000.1
FDC binder standard, red (2)	1 pc.	5000.2
FDC binder standard, blue (3)	1 pc.	5000.3
FDC binder standard, green (4)	1 pc.	5000.4
FDC binder standard, brown (5)	1 pc.	5000.5
Protective slipcase, colour selection No. 1/2/3/4/5	1 pc.	5010.No

incl.
50 foil
pockets



FDC binder extra long

In contrast to the standard FDC binder, which is also made of leather-like plastic (PVC) and can be opened with a snap fastener, this FDC binder can accommodate items up to 250 x 125 mm in size. A pocket on the spine offers the possibility to label the binder.

FDC binder extra long – Set

Format W x H 285 x 145 mm, 2-ring snap fastener, including 50 FDC foil pockets made of clear PP film, with black insert sheet (removable), suitable for 100 letters up to format max. 250 x 125 mm.

Type	Quantity	Order-No.
FDC-Binder extra lang, black (1)	1 pc.	5001.1
FDC-Binder extra lang, red (2)	1 pc.	5001.2
FDC-Binder extra lang, blue (3)	1 pc.	5001.3
FDC-Binder extra lang, green (4)	1 pc.	5001.4
Protective slipcase, colour selection No. 1/2/3/4	1 pc.	5012.No

incl.
50 foil
pockets



STOCKBOOKS



Classic-Line stockbook

Our Classic-Line series of stockbooks are made from specially selected materials. All versions in the 230 x 305 mm format are equipped with a double linen hinged and double glassine interleaves.

The smaller books in the format 165 x 220 mm are offered with a single hinge and one glassine interleaf.

The books with black stock sheets are made in the format 230 x 305 mm with 9, in the format 165 x 220 mm with 6 transparent strips.

The books with white stock sheets, on the other hand, are equipped with 10 glassine strips in the 230 x 305 mm format and 6 glassine strips in the 165 x 220 mm format.



Classic-Line stockbook, black

Black card sides covered with clear foil strips made of PP, with linen hinge and glassine interleaves.

Type	Format mm W x H	Quant.	Order-No. Cover black	Order-No. Cover red	Order-No. Cover blue	Order-No. Cover green	Order-No. Cover brown
8 sheets / 16 pages, 6 foil strips	165 x 220	1 pc.	2004.1	2004.2	2004.3	–	–
8 sheets / 16 pages, 9 foil strips, grained book cover	230 x 305	1 pc.	2010.1	2010.2	2010.3	–	–
16 sheets / 32 pages, 9 foil strips, grained book cover	230 x 305	1 pc.	2015.1	2015.2	2015.3	–	–
24 sheets / 48 pages, 9 foil strips, grained book cover, padded	230 x 305	1 pc.	2025.1	2025.2	2025.3	–	–
32 sheets / 64 pages, 9 foil strips, Book cover in linen look	230 x 305	1 pc.	2035.1	2035.2	2035.3	2035.4	2035.5



Double linen hinge



2035 Linen book cover

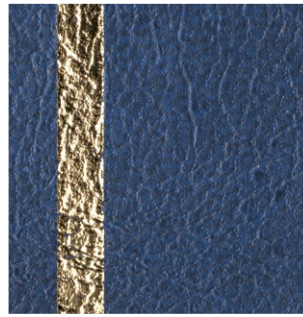

2003-2033 Grained book cover



2033 Center divide



Classic-Line stockbook, white

White card sides covered with glassine strips, with linen hinge and glassine interleaves.

Type	Format mm W x H	Quantity	Order-No. Cover black	Order-No. Cover red	Order-No. Cover blue
8 sheets / 16 pages, 6 glassine strips, grained book cover	165 x 220	1 pc.	2003.1	2003.2	2003.3
8 sheets / 16 pages, 10 glassine strips, grained book cover	230 x 305	1 pc.	2008.1	2008.2	2008.3
16 sheets / 32 pages, 10 glassine strips, grained book cover	230 x 305	1 pc.	2016.1	2016.2	2016.3
24 sheets / 48 pages, 10 glassine strips, grained book cover	230 x 305	1 pc.	2024.1	2024.2	2024.3
32 sheets / 64 pages, 10 glassine strips, grained book cover	230 x 305	1 pc.	2032.1	2032.2	2032.3
32 sheets / 64 pages, 10 glassine strips, grained book cover, center divide	230 x 305	1 pc.	2033.1	2033.2	2033.3

STOCKBOOKS SKYLINE



Stockbook Skyline Gold

Prinz combines the advantages of the classic stockbook with those of a high-quality ring binder system. Skyline Gold is compact and bound in a high-quality hardcover binding in dark grey, berry or ocean blue and subtle finishing with partial UV varnish. Thanks to the spiral binding, the inside pages made of sturdy, black card can be easily turned over and opened completely. Extra strong glassine interleaves protect the foil strips and avoid static build up.

For the first time, Skyline Gold enables a division of 1 to 8 strips. This means that you have eight stockbook variants with strip heights from 27 to 242 mm. Choose the right Skyline Gold stockbook that best fits the stamp sizes in your collection so that your stamps are completely covered and therefore well protected. The high-quality insides made of pH-neutral card are provided with plasticiser-free polyester strips and are therefore absolutely harmless for postage stamps. The strips are crystal clear and have an incomparable clamping effect. Your stamps are shown to their best advantage in terms of colour, sit perfectly and are optimally stored.





Hardcover with partial UV varnish



Modern spiral binding



Practical elastic strap as a closure

Stockbook Skyline Gold

Hardcover in 3 different colours, size W x H 240 x 285 mm, 20 pages / 40 sides, made of black card, 270 gsm, extra thick glassine interleaves, black spiral binding, elastic strap, 8 different sheet configurations with clear polyester strips available.

Type	Format mm W x H	Quantity	Order-No. hardcover dark grey	Order-No. hardcover berry	Order-No. hardcover ocean blue
1 strip each 190 x 242 mm	240 x 285	1 pc.	2721.1	2721.2	2721.3
2 strips each 190 x 119 mm	240 x 285	1 pc.	2722.1	2722.2	2722.3
3 strips each 190 x 79 mm	240 x 285	1 pc.	2723.1	2723.2	2723.3
4 strips each 190 x 58 mm	240 x 285	1 pc.	2724.1	2724.2	2724.3
5 strips each 190 x 45 mm	240 x 285	1 pc.	2725.1	2725.2	2725.3
6 strips each 190 x 37 mm	240 x 285	1 pc.	2726.1	2726.2	2726.3
7 strips each 190 x 31 mm	240 x 285	1 pc.	2727.1	2727.2	2727.3
8 strips each 190 x 27 mm	240 x 285	1 pc.	2728.1	2728.2	2728.3

Stockbook Skyline Silver

Compared to the Skyline Gold series, these are somewhat smaller stock books, also with spiral binding, in the formats 175 x 215 mm with 5 strips, or 160 x 105 mm with 2 strips. The stock books Skyline Silver are equipped with a soft cover and are available in 3 colours.

These products are particularly popular with newcomers. Especially as a selection book for e.g. exchange days, these two stock-books offer an indispensable aid.

Practical and handy
Reliable protection
High-quality materials



Stockbook Skyline Silver

Softcover in 3 different colours, 5 sheets / 10 pages made of black card, 270 gsm, covered with polyester strips, extra strong glassine interleaf, spiral binding in silver colour.

Type	Format mm W x H	Quantity	Order-No. Soft cover red	Order-No. Soft cover blue	Order-No. Soft cover green
2 strips each 140 x 46 mm	160 x 105	1 pc.	2702.2	2702.3	2702.4
5 strips each 157 x 40 mm	175 x 215	1 pc.	2705.2	2705.3	2705.4



Royal-Line stockbook

A luxury product of unrivalled quality. The book cover made of real leather is produced in a special environmentally friendly process. The raised frets in the spine and gold protective corners give this stockbook a true touch of class.

The books of the Royal-Line series are offered with 16 or 30 sheets of content. Both variants are each equipped with 9 crystal clear strips and 2 crystal clear interleaves made of plasticiser-free PP film.

These unique stock books are available in 3 colours.



Royal-Line stockbook

Format W x H 230 x 305 mm, black card sheets, 16 or 30 sheets, covered with 9 clear PP film strips, 2 interleaves made of clear PP film, 4 gold corners.

Type	Quantity	Order-No. Cover black	Order-No. Cover wine red	Order-No. Cover green
Royal-Line, 16 sheets/32 pages	1 pc.	6116.1	6116.2	6116.4
Royal-Line, 30 sheets/60 pages	1 pc.	6130.1	6130.2	6130.4

Stockbook Princess

New in our range you will find stockbooks in 2 different formats with high quality, colour printed book covers. This product is also very popular, especially with newcomers.

The black sheets with 6 or 9 clear PP strips and glassine interleaves are the ideal introduction to the beautiful hobby of stamp collecting.

Stockbook Princess

Unpadded hardcover cover, black card sheets, 8 sheets / 16 pages, covered with clear PP film strips, glassine interleaves.

Format	Type	Quantity	Order-No.
A5	6 strips	1 pc.	3204
A4	9 strips	1 pc.	3208



PHILATELY COLLECTOR'S ACCESSORIES



Cutters

Cutters are an indispensable help for collectors requiring to cut their Prinz strips to size.

Prinz Trimmer

With the help of the measuring scale, in cm and inch, on both sides, our polystyrol strips can be easily trimmed to the required size. The special stainless steel blade sharpens itself with each cut. The robust stand and strong cutter-handle are further signs of quality characteristics.

VANTAGE 50 Trimmer

Sturdy metal base in black with ground circular blade enclosed in a plastic head. The automatic clamping on the cutting line holds the Paper/Foil tight for perfect cutting. Cutting length 320 mm, cutting capacity 0.5 mm.

DAHLE Personal Trimmer

For fast trimming of paper, photos or films. Ground rotating circular blade, two scale bars with cm-graduation, automatic clamping on the cutting line and see-trough paper clamp. Cutting length 320 mm, cutting capacity 0.8 mm.

7021
Dimensions LxWxH
195x142x29 mm



7005
Dimensions LxWxH
420x190x60 mm

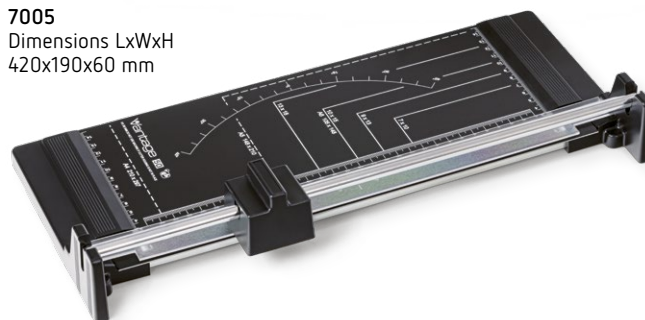

DAHLE

7020
Dimensions LxWxH
435x210x65 mm

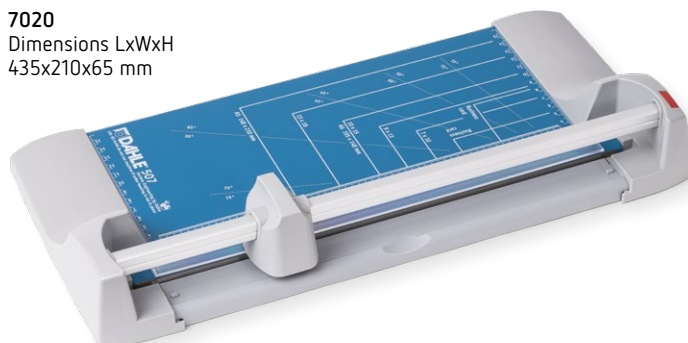

Cutters

Type	Quantity	Order-No.
Prinz, max. 155 mm cutting length	1 pc.	7021
VANTAGE, max. 320 mm cutting length	1 pc.	7005
DAHLE, max. 320 mm cutting length	1 pc.	7020

Magnifiers

Our product range includes hand magnifiers, stand and illuminated magnifiers – ideal for many uses. With magnification factors ranging from 2x to 10x. All illuminated magnifiers use commonly available batteries.

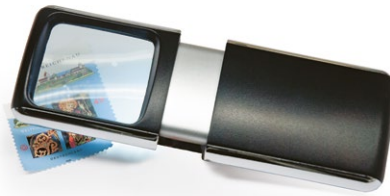

Slide magnifier

3x, with LED light ideal for close inspection, lens size 35 x 40 mm (without battery)

Article	Quantity	Order-No.
---------	----------	-----------

Slide magnifier	1 pc.	7061
-----------------	-------	------



Illuminated magnifier

8x, adjustable focus and millimeter scale, lens Ø 23 mm (without battery)

Article	Quantity	Order-No.
---------	----------	-----------

Illuminated magnifier	1 pc.	7060
-----------------------	-------	------



LED rimless magnifier

3x / 5x, with LED Light, aspheric lens Ø 90 mm, (without batteries)

Article	Quantity	Order-No.
---------	----------	-----------

LED rimless magnifier	1 pc.	3105
-----------------------	-------	------



Illuminated magnifier

2x + 6x, lens 40 x 40 mm (without battery)

Article	Quantity	Order-No.
---------	----------	-----------

Illuminated magnifier	1 pc.	7052
-----------------------	-------	------



Linen Tester

5x, Ø 23 mm, with bi-convex light lens

Article	Quantity	Order-No.
---------	----------	-----------

Linen Tester	1 pc.	7549
--------------	-------	------



Handmagnifier

2x/5x, lens Ø 60 mm

Article	Quantity	Order-No.
---------	----------	-----------

Handmagnifier	1 pc.	7053
---------------	-------	------



Standmagnifier

10x, aplanatic lens, sharply defined edge and distortion free, lens Ø 27 mm

Article	Quantity	Order-No.
---------	----------	-----------

Standmagnifier	1 pc.	7054
----------------	-------	------



Standmagnifier

4x, viewfield for overall inspection lens Ø 55 mm

Article	Quantity	Order-No.
---------	----------	-----------

Standmagnifier	1 pc.	7055
----------------	-------	------



2068 (366 nm)



2069 (256 nm)

UV-Test Lamps

are available in two different versions.

The long-wave light with wavelength 366 nm is used for testing Security papers or fluorescent paper, varieties and banknotes.

The short-wave light with wavelength 256 nm is used to detect phosphor characteristics/bands on stamps (e.g. UK and U.S. stamps).

UV-Test Lamps

Article	Quant.	Order-No.
UV-Test Lamp mains powered 220-240 V		
UV-Test lamp, longwave, 366 nm, 4 W	1 pc.	2050
UV-Test lamp, shortwave, 256 nm, 4 W	1 pc.	2051
UV-Test Lamp battery powered (4 x AA), delivery without batteries		
MINI-UV-Test lamp, longwave 366 nm, 4 W	1 pc.	2068
MINI-UV-Test lamp, shortwave 256 nm, 4 W	1 pc.	2069
Replacement tubes		
Replacement tube, 366 nm, for 2050 and 2068	1 pc.	2063
Replacement tube, 256 nm, for 2051 and 2069	1 pc.	2064

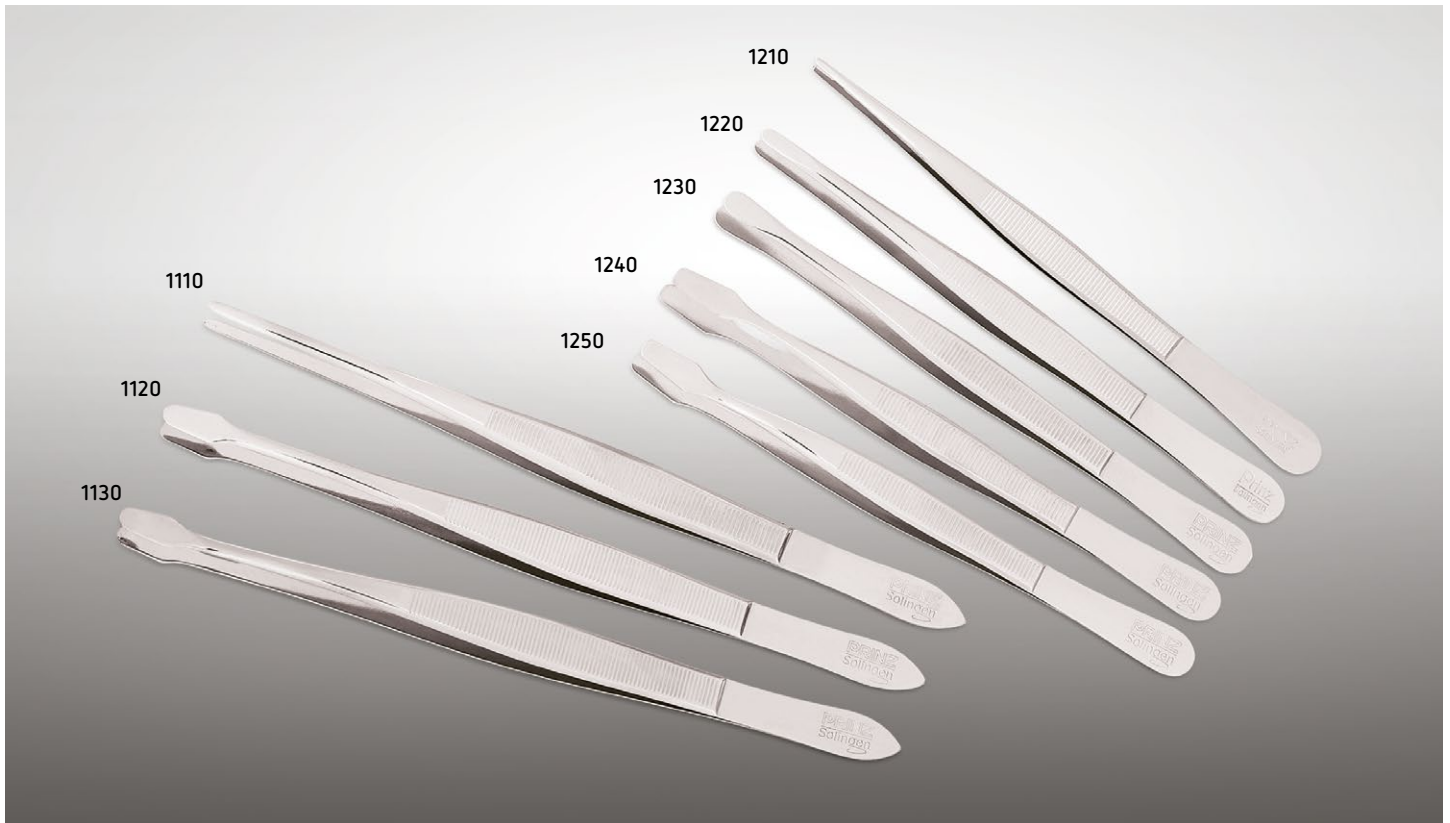

Type 1 very pointed

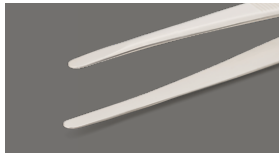

Type 2 pointed



Type 3 spoon



Type 4 spade



Type 5 cranked spade

Tweezers

These indispensable tools made of the best Solingen steel are available in various designs. You can choose from 2 different lengths. Especially the hand-sanded tweezers with a length of 155 mm allow a particularly careful handling of your stamps. The 24 carat gold-plated versions (order no. 1256 and 1121) are particularly popular as gifts. All of our tweezers come in practical protective covers.



Tweezers

Type	Length mm	Quantity	Order-No.
Type 1, nickel-plated	120	1 pc.	1210
Type 2, nickel-plated	120	1 pc.	1220
Type 3, nickel-plated	120	1 pc.	1230
Type 4, nickel-plated	120	1 pc.	1240
Type 5, nickel-plated	120	1 pc.	1250
Type 5, gold plated	120	1 pc.	1256
Type 1, hand grinded	155	1 pc.	1110
Type 4, hand grinded	155	1 pc.	1120
Type 1, gold plated	155	1 pc.	1121
Type 5, hand grinded	155	1 pc.	1130
Tweezer sheath, blue (for Ref. No. 1210-1256)		1 pc.	1007

Corner mounts

Self-adhesive corner mounts made of clear foil, to be unrolled from the practical dispenser box (order no. 2040/1), particularly suitable for letters, postcards, etc. with a length of 22 mm. The slightly larger corner mounts (order no. 2042) with a length of 37 mm are particularly suitable for thicker and heavier documents.



2042

Corner mounts

Type	Quantity	Order-No.
Prinz corner mounts in dispenser, 22 mm	250 pc.	2040/1
Prinz corner mounts, large format, 37 mm	100 pc.	2042



2040/1



Stamp hinges

are the traditional way to attach postage stamps. The narrow end of the short fold is slightly moistened and glued to the back of the stamp. Then moisten the lower half of the long fold and stick it on an album sheet. The special rubber coating allows the fold to peel off at any time.

Stamp hinges

Pre-folded, acid-free gum, finest quality

Type	Quantity	Order-No.
1 bag of 1,000 Prinz hinges	1 pc.	7040
1 Prinz display box with 50 bags	1 pc.	7042
1 packet of 100 bags of Prinz hinges	1 pc.	7044



7042



5090
Dimensions LxWxH
228x163x64 mm

5086
Dimensions LxWxH
160x130x83 mm

5085
Dimensions LxWxH
220x170x100 mm

Storage boxes for stockcards

Prinz storage boxes offer optimal space for the stockcards offered in this program and are available in 3 different versions. They work like the good old card index box. For the storage boxes, order no. 5085 + 5090, we recommend the premium stockcards order no. 810 – 850 and order no. 950 + 960 on pages 9 and 10. The PVC cards, order no. 5091 – 5096, from page 12 as well as the auction cards order no. 600 + 650 from page 13, all in the formats 210 x 148 mm, find space.

For the Prinz storage box order no. 5086, we recommend the slightly smaller premium stockcards order no. 710 – 730 on page 9, in the format 148 x 112 mm.

Storage boxes for stockcards

Type	Quantity	Order-No.
Prinz-cassette, storage box A5, empty	1 pc.	5085
Prinz-cassette, storage box A6, empty	1 pc.	5086
Prinz-cassette slipcase system A5, empty	1 pc.	5090
Register cards, 1 set	1 pc.	0582

COLLECTOR'S ACCESSORIES NUMISMATICS



Coin system Classic

The self-adhesive coin holders with highly transparent foils on both sides reveal every detail. The inexpensive standard coin holders (not self-adhesive) can be closed with the help of a staple. The extra strong PVC album page 238 x 283 mm accepts 20 coin holders. We recommend our padded high-quality binders with gold embossing.

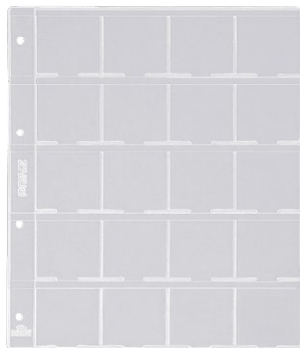

2091



2092



2093

Coin system Classic

Type	Quant.	Order-No.
Format W x H 295 x 310 mm, standard 4-ring mechanism (80-80-80), for max. 20 coin pages, format 245 x 297 mm, matching slipcases made of PVC		
4-ring coin binder, empty, black	1 pc.	2090.1
4-ring coin binder, empty, wine red	1 pc.	2090.2
4-ring coin binder, empty, brown	1 pc.	2090.5
PVC slipcase, black	1 pc.	3018.1
PVC slipcase, wine red	1 pc.	3018.2
PVC slipcase, brown	1 pc.	3018.5

Stockpages and interleaves, format WxH 238 x 283 mm

Stockpage for 20 coin holders for coin holders from 17.5–39.5mm Ø	5 pc.	2091
Interleaves white, for 20 coin holder pages	5 pc.	2092

Coin holders, available in the following diameters:

17.5 / 20 / 22.5 / 25 / 27.5 / 30 / 32.5 / 35 / 37.5 / 39.5 mm

* When ordering please include the required size with the order number.

Coin holders*, self adhesive, for coins from 17.5–39.5 mm Ø	50 pc.	2093+Ø
Coin holders*, self adhesive, for coins from 17.5–39.5 mm Ø	25 pc.	2094+Ø
Coin holders* Standard, closed with staplers (not self adhesive), for coins from 17.5–39.5 mm Ø	30 pc.	2095+Ø
Coin holders assorted , self adhesive, for coins from 17.5–39.5 mm Ø	50 pc.	2098
Coin holders* Standard assorted , closed with staplers (not self adhesive), for coins from 17.5–39.5mm Ø	30 pc.	2099

Coin tweezers

They are available in 2 different versions. Both tweezers are coated with a special coating at the tip for a safe hold.

Coin tweezers

Solingen steel, non-slip coating

Type	Quant.	Order-No.
Coin tweezers, angled tips	1 pc.	1008
Coin tweezers, straight tips	1 pc.	1009



COLLECTOR'S ACCESSORIES NUMISMATICS



Coin system Perfecta

A popular system is our Perfecta coin range, page size 210 x 255mm. The coins are inserted into the pull-out slider then inserted directly into the page. Banknotes can also be incorporated into the system.

Our Perfecta ring binders are welded from high-quality, hard-wearing foil. Another quality feature is the padded design. The recessed embossing on the front completes this binder perfectly.

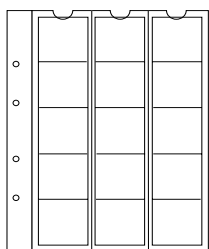

2115

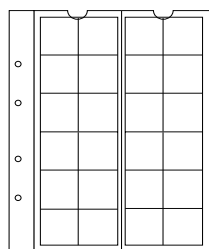

2124

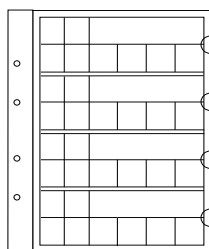

2132 Euro

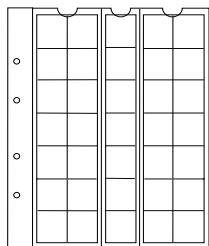

2135

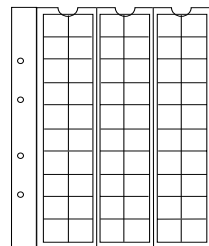

2160

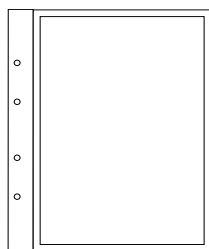

2140

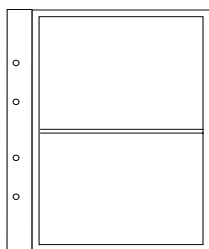

2142

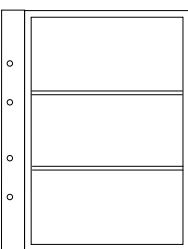

2143

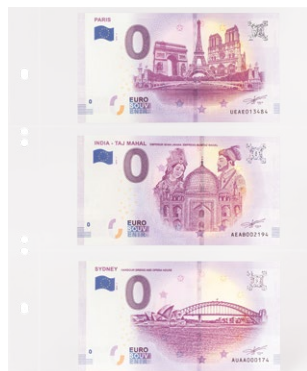

2143

Coin system Perfecta

Type	Quant.	Order-No.
Format W x H 235 x 265 mm, 4-ring mechanism (45-65-45), padded, for max. 15 coin pages, format 210 x 255 mm, matching slipcases made of card		
Perfecta coin album, empty, black	1 pc.	2101.1
Perfecta coin album, empty, red	1 pc.	2101.2
Perfecta coin album, empty, blue	1 pc.	2101.3
Perfecta coin album, empty, green	1 pc.	2101.4
Perfecta coin binder, empty, brown	1 pc.	2101.5
Card slipcase, black	1 pc.	2102.1
Card slipcase, red	1 pc.	2102.2
Card slipcase, blue	1 pc.	2102.3
Card slipcase, green	1 pc.	2102.4
Card slipcase, brown	1 pc.	2102.5

Pages and interleaves, format WxH 210 x 255 mm

Coin album page with 15 pockets up to Ø 45 mm inc. 5 black interleaves	5 pc.	2115
Coin album page with 24 pockets up to Ø 31 mm inc. 5 black interleaves	5 pc.	2124
Coin album page with 35 pockets up to Ø 28 mm inc. 5 black interleaves	5 pc.	2135
Coin album page with 60 pockets up to Ø 23 mm inc. 5 black interleaves	5 pc.	2160
EURO special for 4 sets of Euro-coins inc. 5 black interleaves	5 pc.	2132
Banknote pages, 1 pocket each, size 180 x 245 mm, inc. 5 black interleaves	5 pc.	2140
Banknote pages, 2 pocket each, size 180 x 115 mm, inc. 5 black interleaves	5 pc.	2142
Banknote pages, 3 pocket each, size 180 x 80 mm, inc. 5 black interleaves	5 pc.	2143
Interleaves, black	5 pc.	2103
Set of Euro flags (19 countries + Vatican, San Marino, Andorra and Monaco)	1 pc.	2104



2104



Coin album Standard

For safe storage of your coins. Each coin pocket has a flap that prevents the coin from falling out. Our coin pages are made from PVC film with a size of 175 x 215 mm. The matching coin binder with 4-ring mechanism in the format 215 x 230 mm, padded, is available in 5 colours.

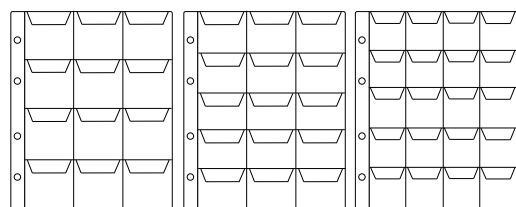

2812

2815

2820

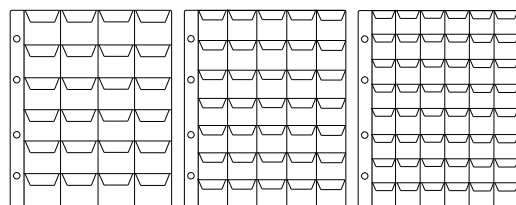

2824

2835

2848

Coin album Standard

Type	Quant.	Order-No.
Format W x H 215 x 230 mm, 4-ring mechanism (45-65-45), padded, for max. 15 coin pages, format 175 x 215 mm, matching slipcase made of card		
Coin album Standard, empty, black (1)	1 pc.	2800.1
Coin album Standard, empty, red (2)	1 pc.	2800.2
Coin album Standard, empty, blue (3)	1 pc.	2800.3
Coin album Standard, empty, green (4)	1 pc.	2800.4
Coin album Standard, empty, brown (5)	1 pc.	2800.5
Card slipcase, colour selection No. 1/2/3/4/5	1 pc.	5031.No

Coin pages

Coin pages for 12 coins Ø 50 mm	5 pc.	2812
Coin pages for 15 coins Ø 40 mm	5 pc.	2815
Coin pages for 20 coins Ø 35 mm	5 pc.	2820
Coin pages for 24 coins Ø 30 mm	5 pc.	2824
Coin pages for 30 coins Ø 25 mm	5 pc.	2835
Coin pages for 48 coins Ø 22 mm	5 pc.	2848

EURO collector's album

For practical storage of your EURO coins. Collecting Euro coins is easy and attractive by simply inserting the coins into the card holders supplied and by sticking the corresponding countries / flags on. The album comprises of a binder and 6 pages with 12 coin set card holders as well as a sheet of nationality flags, country names, dates and information folders with all 19 EURO countries + Vatican, San Marino, Andorra and Monaco.

EURO collector's album

Format W x H 195 x 225 mm, 4-ring mechanism (45-65-45), padded, with 6 pages and 12 EURO coin set card holders

Type	Quant.	Order-No.
EURO collector's album set , wine red	1 pc.	2300.2
EURO collector's album set , blue	1 pc.	2300.4
EURO collector's album set , silver	1 pc.	2300.6
EURO collector's album, empty , wine red	1 pc.	2303.2
EURO collector's album, empty , blue	1 pc.	2303.4
EURO collector's album, empty , silver	1 pc.	2303.6
EURO Coin-Covers for EURO-Coin-Sets each with 2 insertion-cards	5 pc.	2301
EURO Coin-Covers for 2-EURO-Coins each with 2 insertion-cards	5 pc.	2302



2301





Flexible diameter

Patent case

Patent cases do not have a prefabricated recess and can therefore be used very individually. They are made of hard plastic and are available in different sizes. By pushing in the coin, a perfectly fitting recess with a secure hold is created. The patent cases are available in the colours: blue, red, white – optionally with a blue or red insert.



1. Align and press in.

Patent case

Plastic case in various sizes and colours with a patent insert

Size	Colour outside/inside	Quantity	Order-No.
Case 40 x 40 mm	blue/red	1 pc.	2441
Case 60 x 60 mm	white/blue	1 pc.	2443
Case 60 x 60 mm	blue/red	1 pc.	2444
Case 60 x 60 mm	red/red	1 pc.	2445
Case 50 x 80 mm	white/blue	1 pc.	2446
Case 50 x 80 mm	blue/red	1 pc.	2447
Case 50 x 80 mm	red/red	1 pc.	2448
Case 80 x 80 mm	white/blue	1 pc.	2449
Case 80 x 80 mm	blue/red	1 pc.	2450
Case 80 x 80 mm	red/red	1 pc.	2451
Case 80 x 200 mm	white/blue	1 pc.	2452
Case 80 x 200 mm	blue/red	1 pc.	2453
Case 80 x 200 mm	red/red	1 pc.	2454
Case 165 x 190 mm	blue/blue	1 pc.	2456



2. The memory foam retains its shape.



3. The collector's item fits perfectly.



Coin cases Standard

The plastic cases offered in the colours blue or red are available for coins of different sizes. The cases, all 60 x 60 mm in size, are made of hard plastic and are available with prefabricated recesses with a diameter of 16 - 41 mm. The inlays are made of blue or red velvet. This product is suitable for demanding storage and offers safe protection during shipping.

Coin cases Standard

Plastic case 60 x 60 mm, with velvet inlay, please add the desired colour code 2 (red) or 3 (blue) to the order number.

Type	Quantity	Order-No.
Case red (2)/blue (3), for 16 mm Ø	1 pc.	2469.No
Case red (2)/blue (3), for 20 mm Ø	1 pc.	2470.No
Case red (2)/blue (3), for 22 mm Ø	1 pc.	2471.No
Case red (2)/blue (3), for 28 mm Ø	1 pc.	2472.No
Case red (2)/blue (3), for 37 mm Ø	1 pc.	2474.No
Case red (2)/blue (3), for 40 mm Ø	1 pc.	2475.No
Case blue, for 41 mm Ø	1 pc.	2476



Coin capsules

Collecting coins in coin capsules is now preferred by many collectors. The high-quality polypropylene guarantees reliable protection. The surface is absolutely clear and scratch-resistant. Your coin is safe and well-kept in it.

Coin capsules

Polypropylene capsules, clear and scratch-resistant

Following Ø-sizes (inner Ø) are available: 14 - 15 - 16 - 16.5 - 17 - 18 - 19 - 20 - 21 - 21.5 - 22 - 22.5 - 23 - 23.5 - 24 - 24.5 - 25 - 26 - 27 - 28 - 29 - 29.5 - 30 - 31 - 32 - 32.5 - 33 - 34 - 35 - 36 - 37 - 38 - 39 - 40 - 41 - 42 mm

The outer diameter is around 6 mm larger.

Please add the size you want to the order number.

Type	Quantity	Order-No.
Coin capsules Ø 14-42	10 pc.	2600+Ø
Coin capsules Ø 14-42	100 pc.	2600(100)+Ø

Coin wallets

Our coin wallets are one of the easiest and cheapest ways to send out coins, e.g. accommodate for shipping. They are offered in two different sizes for coins with a diameter of up to 25 mm and coins with a diameter of 45 mm.

Coin wallets

Grained flap made of PVC

Type	Quantity	Order-No.
Coin wallets up to 25 mm Ø	100 pc.	2525
Coin wallets up to 45 mm Ø	100 pc.	2545



From Passau into the world

Prinz supplies its products to passionate, quality-conscious collectors worldwide. The company is presented by sales partners who operate as independent agents in more than 30 countries.

- Distribution partner
- PRINZ VERLAG Passau, Germany

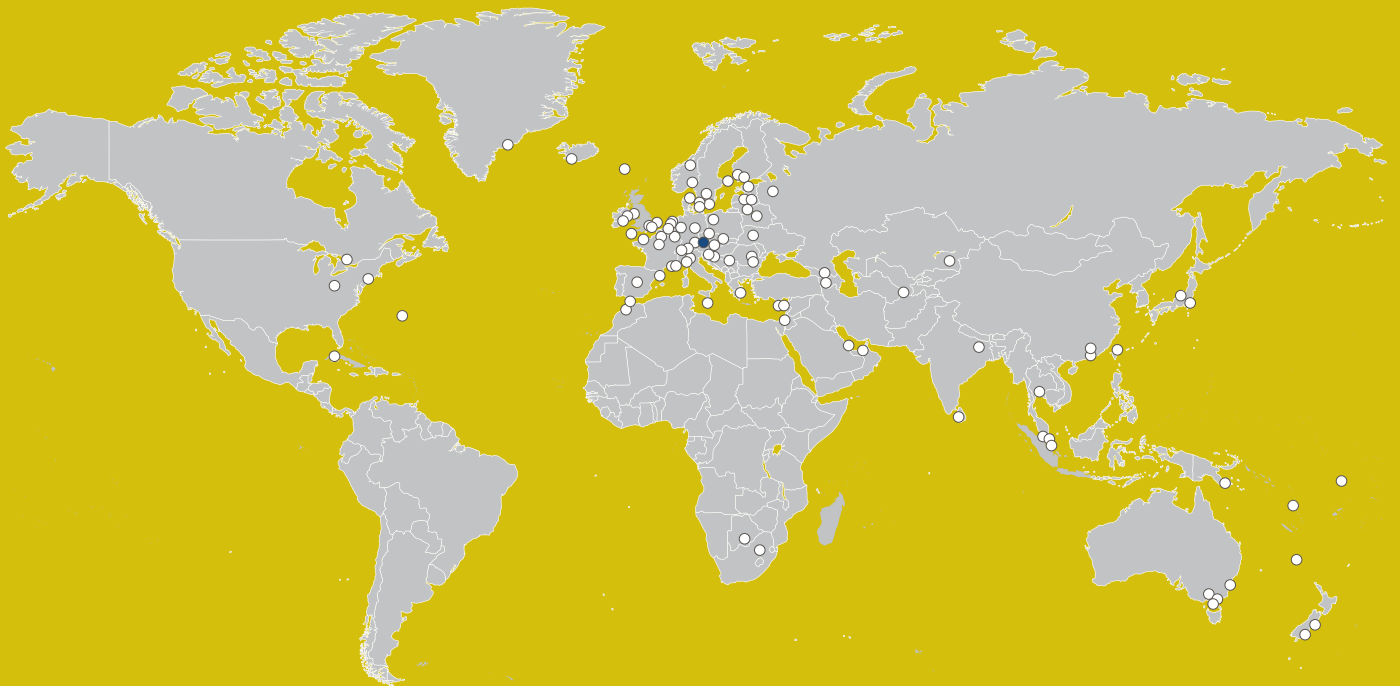

Legal Notice

All stamps, letters, coins etc. used in the illustrations in this catalogue are collective examples and are not included in the delivery.

All prices quoted are non-binding price recommendations including the currently applicable VAT.

Changes and errors excepted. All deliveries correspond to our current delivery and payment conditions. For all purchases, we refer to our terms and conditions at www.prinzverlag.de.

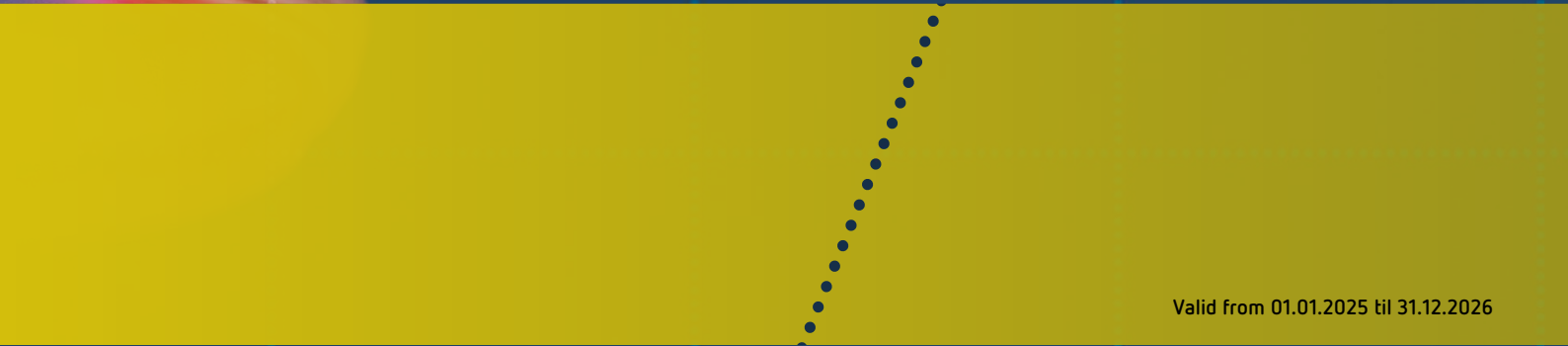
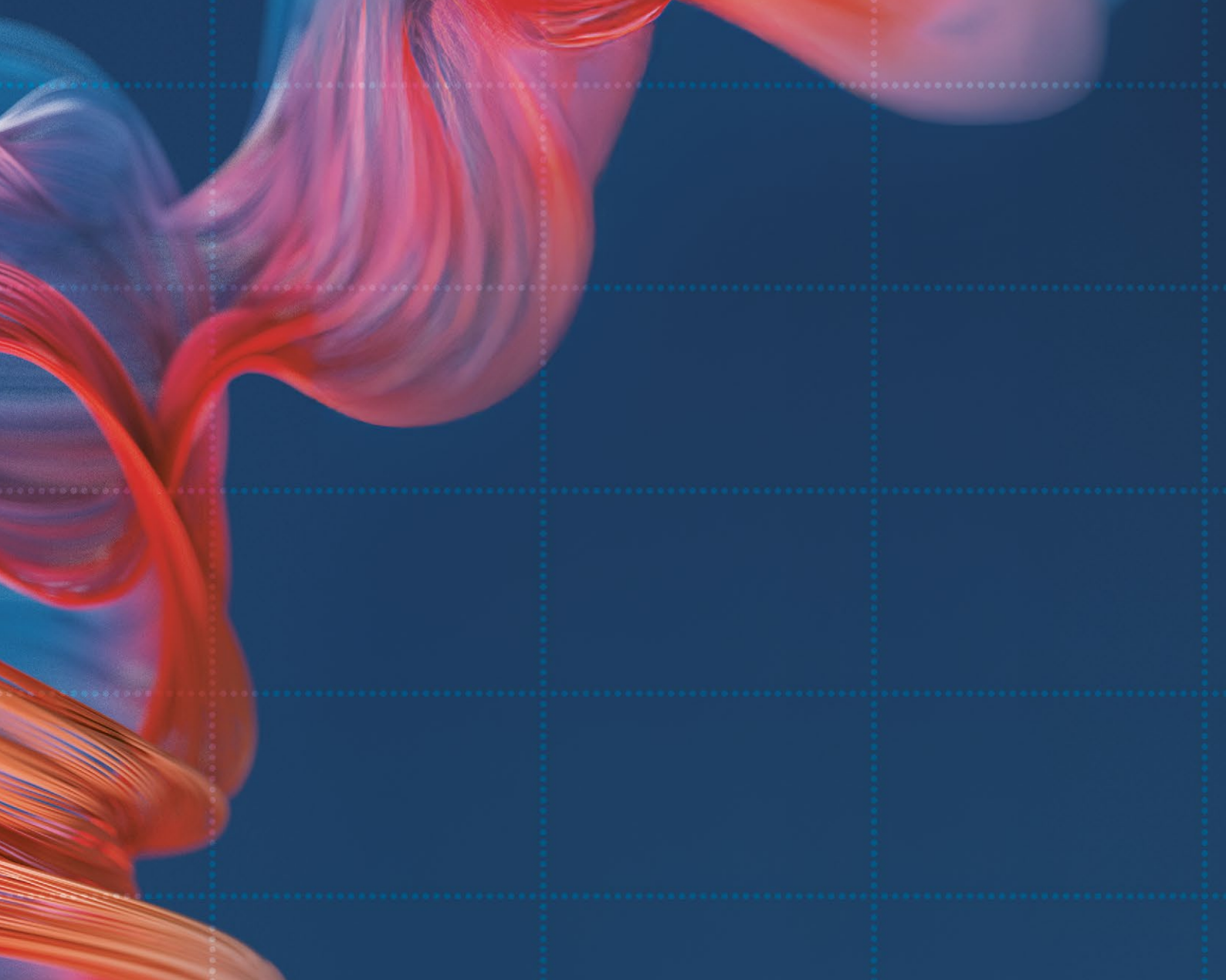

Valid from 01.01.2025 til 31.12.2026

